



Logitech® G402 Hyperion Fury™

Setup Guide



## Contents

English . . . . .	3	Svenska . . . . .	24
Deutsch . . . . .	6	Dansk . . . . .	27
Français . . . . .	9	Norsk . . . . .	30
Italiano . . . . .	12	Suomi . . . . .	33
Español . . . . .	15	Ελληνικά . . . . .	36
Português . . . . .	18	Türkçe . . . . .	39
Nederlands . . . . .	21	42 . . . . .	العربية

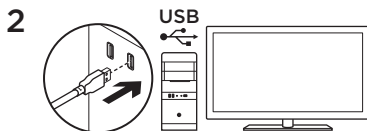
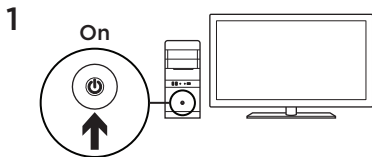

Your G402 Hyperion Fury is ready to play games. If you would like to customize your Hyperion Fury , refer to the next section.

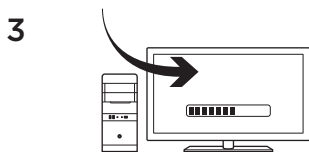

You can customize the onboard profile of the G402 Hyperion Fury—button programming and tracking behavior—using the Logitech Gaming Software. Download this free software and learn how to customize the Hyperion Fury at [www.logitech.com/support/g402hyperionfury](http://www.logitech.com/support/g402hyperionfury)

## 8 fully programmable buttons

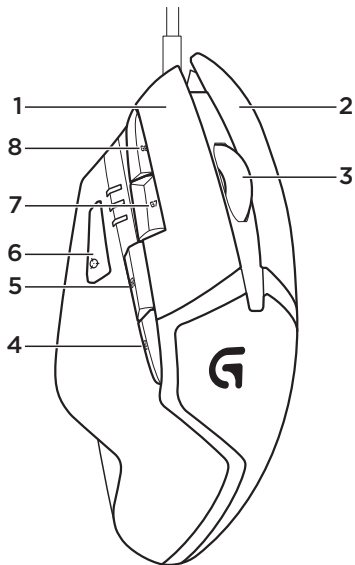

1. Left (Button 1)
2. Right (Button 2)
3. Wheel click (Button 3)
4. Back (Button 4)
5. Forward (Button 5)
6. DPI Shift (Button G6)
7. DPI Down (Button G7)
8. DPI Up (Button G8)

### Default Settings:

DPI Values: 400/800/1600/3200

DPI Shift Value: 400

USB Report Rate: 1000/sec (1ms)

Logo lighting:

On, with breathing effect

## Onboard profile

Hyperion Fury allows you to tweak your settings until they are perfect and store them in its onboard memory. You can adjust button functions, DPI values, USB report rate, and logo lighting style using the optional Logitech Gaming Software, available for download from [www.logitech.com/support/g402hyperionfury](http://www.logitech.com/support/g402hyperionfury).

## DPI indicators

DPI values are shown using the three LEDs indicated in the mouse drawing. The image below shows which DPI value is being indicated by the LED panel.

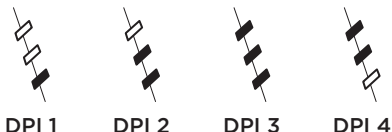

## Tips

Try the default profile settings in practice games before changing these settings.

Advanced gamers can customize each game according to their specific button configuration and sensitivity switching needs. In automatic game detection mode, the Logitech Gaming Software stores this information and applies it automatically when the game is detected.

[www.logitech.com/support/g402hyperionfury](http://www.logitech.com/support/g402hyperionfury)

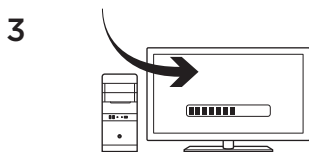
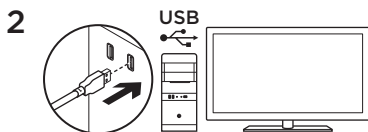
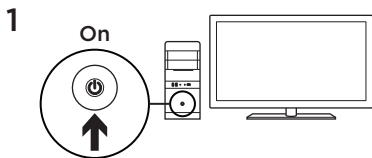

Deine G402 Hyperion Fury will spielen. Informationen zur Anpassung Deiner Hyperion Fury findest Du im nächsten Abschnitt.

Du kannst das integrierte Profil der G402 Hyperion Fury für Tastenprogrammierung und Abtastverhalten mit der Logitech Gaming Software anpassen. Unter [www.logitech.com/support/g402hyperionfury](http://www.logitech.com/support/g402hyperionfury) sind die kostenlose Software und Informationen zur Anpassung der Hyperion Fury verfügbar.

## 8 voll programmierbare Tasten

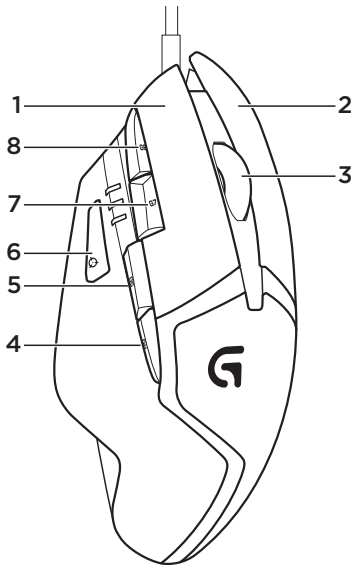

1. Links (Taste 1)
2. Rechts (Taste 2)
3. Mausradklick (Taste 3)
4. Zurück (Taste 4)
5. Vorwärts (Taste 5)
6. DPI-Wechsel (Taste G6)
7. Auflösung verringern (Taste G7)
8. Auflösung erhöhen (Taste G 8)

### Standardeinstellungen:

DPI-Werte: 400/800/1600/3200

DPI-Umschaltwert: 400

USB-Signalrate: 1000/Sek. (1 ms)

Logo-Beleuchtung:

Ein - mit Blinkeneffekt

## Integriertes Profil

Mit Hyperion Fury kannst Du Deine Einstellungen individuell optimieren und sie im integrierten Speicher speichern. Mithilfe der optionalen Logitech Gaming Software, die unter [www.logitech.com/support/g402hyperionfury](http://www.logitech.com/support/g402hyperionfury) heruntergeladen werden kann, lassen sich Tastenfunktionen, DPI-Werte, die USB-Signalrate und die Logo-Beleuchtung anpassen.

## DPI-Anzeigen

Die DPI-Werte werden mithilfe der drei auf der Abbildung dargestellten LEDs angezeigt. Die Abbildung unten zeigt, wie die einzelnen DPI-Werte über die LEDs angezeigt werden.

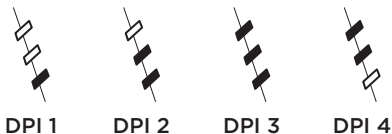

## Tipps

Teste vor dem Ändern von Einstellungen die Standardeinstellungen in Probespielen. Erfahrene Spieler können für jedes Spiel eine individuelle Tastenbelegung und Empfindlichkeitsumschaltung einstellen. In der automatischen Spielerkennung speichert die Logitech Gaming Software diese Informationen und wendet sie automatisch an, wenn das Spiel erkannt wird.

[www.logitech.com/support/g402hyperionfury](http://www.logitech.com/support/g402hyperionfury)



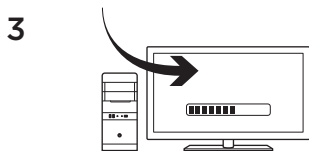
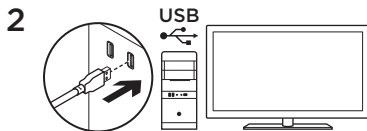
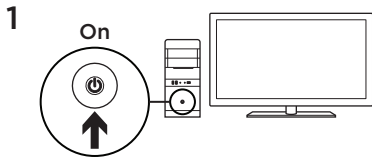

Votre souris G402 Hyperion Fury est prête à l'emploi. Reportez-vous à la section suivante si vous souhaitez personnaliser son utilisation.

Il est possible de personnaliser le profil enregistré de la souris G402 Hyperion Fury, notamment la programmation des boutons et le comportement de suivi, à l'aide de l'assistant pour jeux vidéo de Logitech. Téléchargez ce logiciel gratuit et découvrez comment personnaliser votre souris Hyperion Fury, en vous rendant sur [www.logitech.com/support/g402hyperionfury](http://www.logitech.com/support/g402hyperionfury).

## 8 boutons entièrement programmables

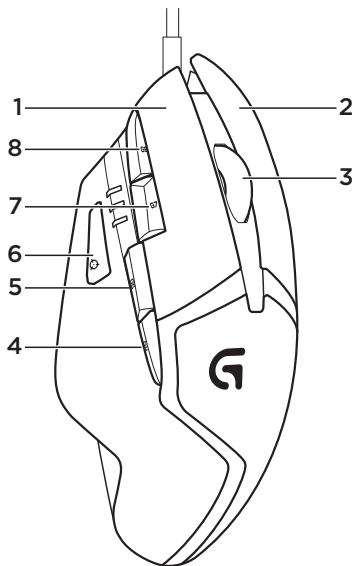

1. Gauche (bouton 1)
2. Droit (bouton 2)
3. Clic de roulette (bouton 3)
4. Précédent (bouton 4)
5. Suivant (bouton 5)
6. Changement de résolution (bouton G6)
7. Diminution de la résolution (bouton G7)
8. Augmentation de la résolution (bouton G8)

### Paramètres par défaut:

Valeurs PPP: 400/800/1600/3200

Valeur de changement de résolution: 400

Taux de rapports USB: 1000/sec (1 ms)

Rétroéclairage du logo:

avec option Effet de pulsation

## Profil enregistré

Le modèle Hyperion Fury vous permet d'ajuster vos paramètres à la perfection et de les enregistrer dans la mémoire intégrée. Vous pouvez régler les fonctions des boutons, les valeurs PPP, le taux de rapport USB et le style de rétroéclairage grâce à l'assistant pour jeux vidéo de Logitech, disponible au téléchargement sur [www.logitech.com/support/g402hyperionfury](http://www.logitech.com/support/g402hyperionfury).

## Témoins lumineux PPP

Les valeurs PPP sont illustrées à l'aide des trois témoins lumineux sur le schéma de la souris. L'image ci-dessous signale quelle valeur PPP est indiquée par le panneau des témoins lumineux.

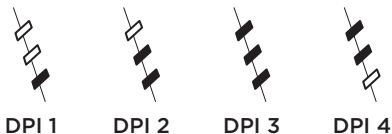

## Conseils

Avant de modifier les paramètres de profil par défaut, vérifiez d'abord leur efficacité dans le jeu.

Les joueurs expérimentés peuvent personnaliser chaque jeu selon leurs besoins spécifiques en matière de changement de sensibilité et de configuration de boutons. Grâce au mode de détection de jeu automatique, l'assistant pour jeux vidéo de Logitech stocke ces informations et les applique automatiquement lorsque le jeu est détecté.

[www.logitech.com/support/g402hyperionfury](http://www.logitech.com/support/g402hyperionfury)

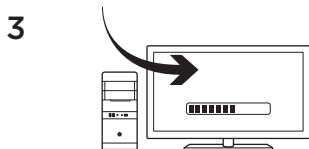
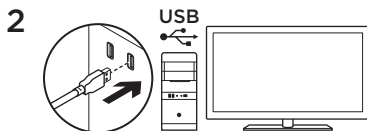
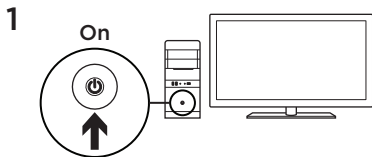

G402 Hyperion Fury è pronto per giocare. Se si desidera personalizzare Hyperion Fury, consultare la sezione successiva.

È possibile personalizzare il profilo integrato di G402 Hyperion Fury (programmazione dei pulsanti e comportamento di tracciamento) utilizzando Logitech Gaming Software. Per scaricare il software gratuito e ottenere ulteriori informazioni su come personalizzare Hyperion Fury, visitare il sito Web [www.logitech.com/support/g402hyperionfury](http://www.logitech.com/support/g402hyperionfury)

## 8 pulsanti programmabili

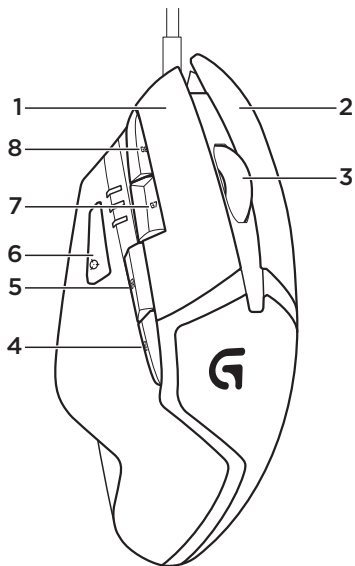

1. Sinistro (pulsante 1)
2. Destro (pulsante 2)
3. Clic con lo scroller (pulsante 3)
4. Indietro (pulsante 4)
5. Avanti (pulsante 5)
6. Cambio DPI (pulsante G6)
7. Riduzione DPI (pulsante G7)
8. Aumento DPI (pulsante G8)

### **Impostazioni predefinite:**

Valori DPI: 400/800/1600/3200

Valore cambio DPI: 400

Frequenza di aggiornamento USB:  
1000/sec (1 ms)

Illuminazione logo:  
attivata, con dissolvenza ciclica

## Profilo integrato

Hyperion Fury consente di regolare le impostazioni alla perfezione e di memorizzarle nella memoria integrata. È possibile impostare le funzioni dei pulsanti, i valori DPI, la frequenza di aggiornamento USB e la modalità di illuminazione del logo utilizzando Logitech Gaming Software, disponibile per il download da [www.logitech.com/support/g402hyperionfury](http://www.logitech.com/support/g402hyperionfury).

## Indicatori DPI

I valori DPI vengono mostrati utilizzando i tre LED indicati nell'illustrazione sotto del mouse. L'immagine riportata sotto mostra quale valore DPI è indicato dal pannello LED.



DPI 1



DPI 2



DPI 3



DPI 4

## Suggerimenti

Provare le impostazioni dei profili predefiniti durante le sessioni di gioco di prova prima di modificarle.

Gli utenti esperti possono personalizzare ogni gioco in base alla configurazione specifica dei pulsanti e alle esigenze di selezione della sensibilità. Nella modalità di rilevamento gioco automatico, Logitech Gaming Software memorizza queste informazioni e le applica automaticamente quando rileva il gioco.

[www.logitech.com/support/g402hyperionfury](http://www.logitech.com/support/g402hyperionfury)

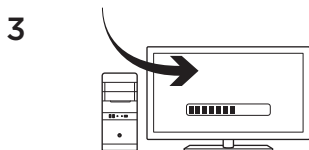
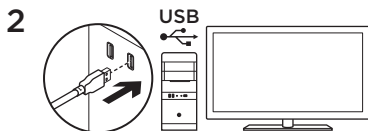
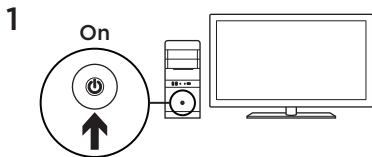

El ratón G402 Hyperion Fury está listo para usar. Si desea personalizar Hyperion Fury, consulte la sección siguiente.

Puede personalizar los perfiles integrados en G402 Hyperion Fury (programación de botones y comportamiento de seguimiento) mediante Logitech Gaming Software. Para descargar este software gratuito y aprender a personalizar Hyperion Fury, acceda a [www.logitech.com/support/g402hyperionfury](http://www.logitech.com/support/g402hyperionfury)

## Ocho botones totalmente programables

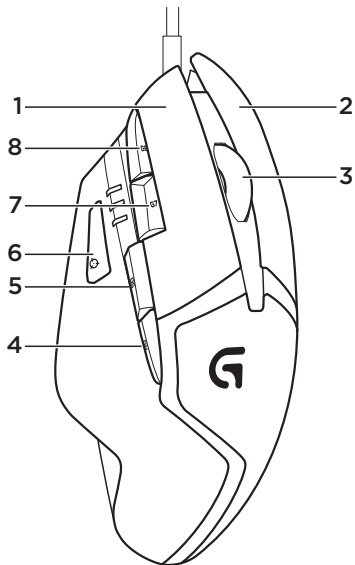

1. Izquierda (botón 1)
2. Derecha (botón 2)
3. Clic con botón rueda (botón 3)
4. Retroceso (botón 4)
5. Avance (botón 5)
6. Cambio de DPI (botón G6)
7. Reducir DPI (botón G7)
8. Aumentar DPI (botón G8)

### Configuración predeterminada:

Valores de DPI: 400/800/1600/3200

Valor de cambio de DPI: 400

Respuesta USB: 1000/s (1 ms)

Iluminación de logotipo:

Activada, parpadeante



## Perfil integrado

Hyperion Fury permite ajustar los parámetros hasta obtener una configuración perfecta y almacenarlos en la memoria integrada. Puede ajustar las funciones de los botones, los valores de DPI, la velocidad de respuesta USB y el estilo de iluminación del logotipo mediante el software opcional Logitech Gaming Software, disponible en [www.logitech.com/support/g402hyperionfury](http://www.logitech.com/support/g402hyperionfury).

## Sugerencias

Antes de cambiar la configuración de los perfiles predeterminados, pruébela en algunos juegos.

Los jugadores expertos pueden personalizar cada juego según los requisitos de configuración de botones y cambios de sensibilidad específicos. En el modo de detección automática de juegos, Logitech Gaming Software guarda esta información y la aplica automáticamente cuando detecta el juego.

## Indicadores de DPI

Los valores de DPI se indican haciendo uso de los tres LED marcados en el dibujo del ratón. La imagen siguiente muestra qué valor de DPI se indica en el panel LED.

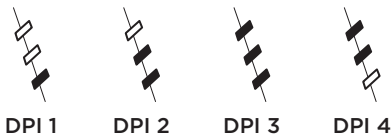

[www.logitech.com/support/g402hyperionfury](http://www.logitech.com/support/g402hyperionfury)

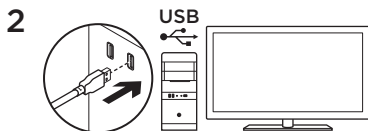
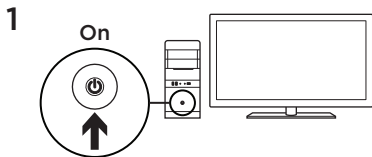

O seu G402 Hyperion Fury está pronto para jogar. Se desejar personalizar o seu Hyperion Fury, consulte a próxima secção.

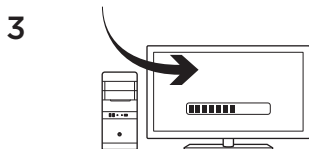

Pode personalizar o perfil integrado do G402 Hyperion Fury, como programação de botões e comportamento de rastreio, com o software Logitech Gaming. Transfira este software gratuito e saiba como personalizar o Hyperion Fury em [www.logitech.com/support/g402hyperionfury](http://www.logitech.com/support/g402hyperionfury)

## 8 botões totalmente programáveis

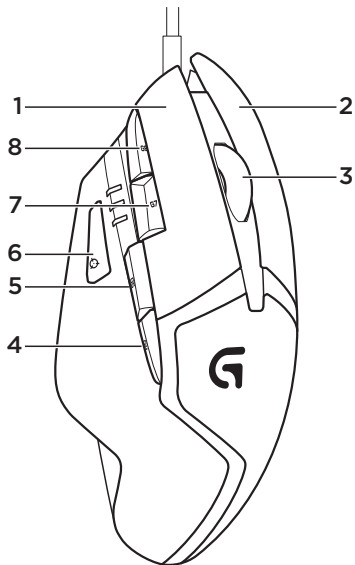

1. Esquerda (Botão 1)
2. Direita (Botão 2)
3. Clique da roda (Botão 3)
4. Retroceder (Botão 4)
5. Avançar (Botão 5)
6. Mudança de ppp (Botão G6)
7. Diminuir PPP (Botão G7)
8. Aumentar PPP (Botão G8)

### **Predefinições:**

Valores de PPP: 400/800/1600/3200

Valor de mudança de PPP: 400

Taxa de relatório USB: 1000/seg. (1ms)

Iluminação de logótipo:

Activado, com efeito pulsação

## Perfil integrado

O Hyperion Fury permite-lhe otimizar as suas definições até à perfeição e armazená-las na memória interna. Pode ajustar as funções de botões, os valores de PPP, a taxa de relatório USB e o estilo da iluminação de logótipo com o software opcional Logitech Gaming, disponível para transferência em [www.logitech.com/support/g402hyperionfury](http://www.logitech.com/support/g402hyperionfury).

## Indicadores de PPP

Os valores de PPP são apresentados com os três LEDs indicados na imagem do rato. A imagem abaixo apresenta qual o valor de PPP indicado pelo painel LED.

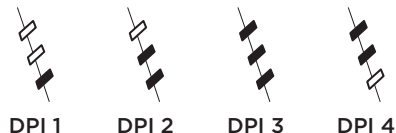

## Sugestões

Experimente as definições do perfil predefinido em jogos de treino antes de alterar estas definições.

Os jogadores avançados podem personalizar cada jogo de acordo com as suas necessidades específicas de alteração de sensibilidade e de configuração de botões. No modo de detecção automática de jogo, o software Logitech Gaming armazena esta informação e aplica-a automaticamente quando o jogo é detectado.

[www.logitech.com/support/g402hyperionfury](http://www.logitech.com/support/g402hyperionfury)

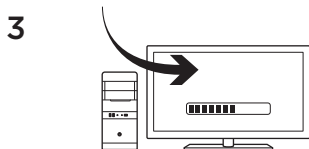
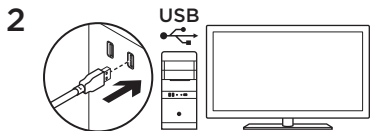
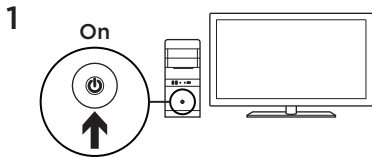

Je G402 Hyperion Fury is klaar om te gamen. Ga naar de volgende sectie als je de Hyperion Fury wilt aanpassen.

Via de Logitech Gaming Software kun je het ingebouwde profiel van de G402 Hyperion Fury aanpassen, waaronder knopprogrammering en trackinggedrag. Download deze gratis software en ontdek hoe je de Hyperion Fury kunt aanpassen op [www.logitech.com/support/g402hyperionfury](http://www.logitech.com/support/g402hyperionfury)

## 8 volledig programmeerbare knoppen

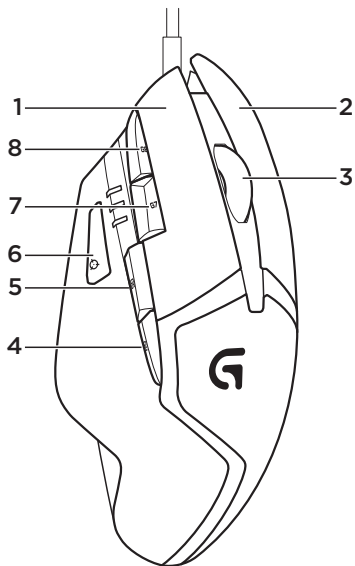

1. Links (knop 1)
2. Rechts (knop 2)
3. Wielklik (knop 3)
4. Terug (knop 4)
5. Volgende (knop 5)
6. DPI-verschuiving (knop G6)
7. DPI omlaag (knop G7)
8. DPI omhoog (knop G8)

### Standaardinstellingen:

DPI-waarden: 400/800/1600/3200

DPI-verschuivingswaarde: 400

USB-rapportagesnelheid: 1000/sec (1 ms)

Logoverlichting: aan, met ademend effect

## Ingebouwd profiel

Je kunt je instellingen voor de Hyperion Fury verfijnen tot ze perfect zijn en dan opslaan in het ingebouwde geheugen. Met behulp van de optionele Logitech Gaming Software (beschikbaar voor download op [www.logitech.com/support/g402hyperionfury](http://www.logitech.com/support/g402hyperionfury)) kun je knopfuncties, DPI-waarden, USB-rapportagesnelheid en de stijl van de logoverlichting aanpassen.

## DPI-indicators

DPI-waarden worden weergegeven via drie leds zoals aangegeven in de tekening van de muis. De onderstaande afbeelding laat zien welke DPI-waarde wordt aangegeven door de leds.

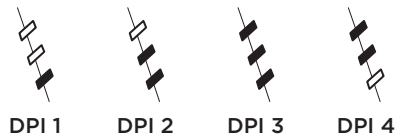

## Tips

Probeer de standaardprofielinstellingen uit in oefengames voordat je ze wijzigt.

Geavanceerde gamers kunnen elke game aanpassen volgens hun specifieke vereisten voor knopconfiguraties en gevoeligheid.

In de modus Automatische gamedetectie slaat de Logitech Gaming Software deze gegevens op om ze vervolgens automatisch toe te passen wanneer de game gedetecteerd wordt.

[www.logitech.com/support/g402hyperionfury](http://www.logitech.com/support/g402hyperionfury)

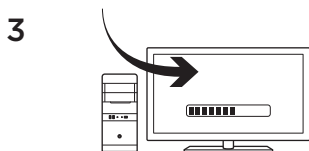
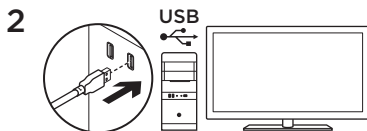
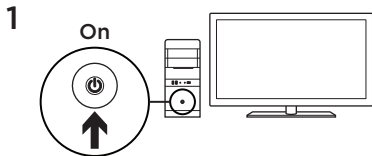

Du kan nu börja spela med din G402 Hyperion Fury-mus. Gå vidare till nästa avsnitt för att se hur du anpassar Hyperion Fury-musen.

Du kan anpassa den inbyggda profilen som ingår i G402 Hyperion Fury – programmering av knappar och avläsningskapacitet – med Logitech Gaming Software. Ladda ner den kostnadsfria programvaran och lär dig hur du anpassar Hyperion Fury på [www.logitech.com/support/g402hyperionfury](http://www.logitech.com/support/g402hyperionfury)



## 8 fullt programmerbara knappar

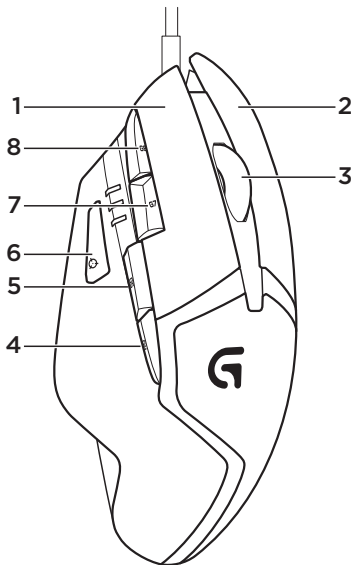

1. Vänster (knapp 1)
2. Höger (knapp 2)
3. Klicka på hjulet (knapp 3)
4. Bakåt (knapp 4)
5. Framåt (knapp 5)
6. Dpi-växling (knapp G6)
7. Dpi ner (knapp G7)
8. Dpi upp (knapp G8)

### Standardinställningar:

Dpi-värden: 400/800/1600/3200

Dpi-växlingsvärde: 400

USB-rapporteringsfrekvens:  
1 000/sek (1 ms)

Logotypsbelysning:

På, med dimmereffekt

## Inbyggd profil

Du kan anpassa Hyperion Fury-inställningarna efter dina behov och sedan lagra dem i det inbyggda minnet. Justera knappfunktioner, dpi-värden, USB-rapporteringsfrekvens och belysning med hjälp av den valfria programvaran Logitech Gaming Software. Programvaran kan laddas ner från [www.logitech.com/support/g402hyperionfury](http://www.logitech.com/support/g402hyperionfury).

## Dpi-indikatorer

Dpi-värdena visas i de tre indikatorerna som syns på bilden. Bilden nedan visar hur dpi-värdet visas i indikatorpanelen.

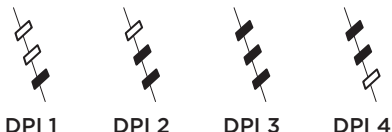

## Tips

Innan du ändrar inställningarna bör du först provspela med standardinställningarna.

Avancerade spelare har möjlighet att anpassa varje enskilt spel efter specifika knappkonfigurationer och känslighetsbehov. Om du har valt automatiskt spelidentifieringsläge lagrar Logitech Gaming Software informationen och tillämpar den automatiskt när det aktuella spelet identifieras.

[www.logitech.com/support/g402hyperionfury](http://www.logitech.com/support/g402hyperionfury)

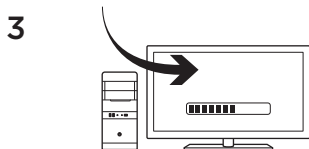
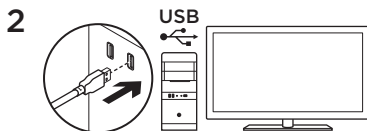
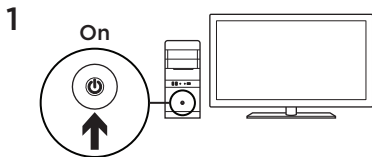

Du kan nu spille med G402 Hyperion Fury. Hvis du vil tilpasse din Hyperion Fury, kan du læse mere i næste afsnit.

Du kan tilpasse den indbyggede profil i G402 Hyperion Fury - knapprogrammering og markørbevægelser - ved hjælp af Logitech Gaming Software. Hent den gratis software, og find ud af hvordan du tilpasser Hyperion Fury, på [www.logitech.com/support/g402hyperionfury](http://www.logitech.com/support/g402hyperionfury)

## 8 programmerbare knapper

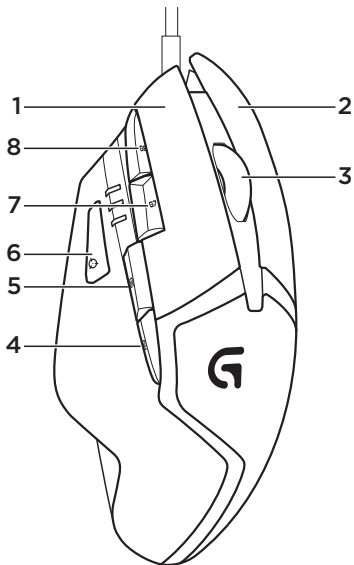

1. Venstre (knap 1)
2. Højre (knap 2)
3. Hjulknop (knap 3)
4. Tilbage (knap 4)
5. Fremad (knap 5)
6. Skift følsomhed (knap G6)
7. Mindre dpi (knap G7)
8. Mere dpi (knap G8)

### Standardindstillinger:

Dpi-værdier: 400/800/1600/3200

Dpi-skift-værdi: 400

USB-rapporteringshastighed:  
1000/sek (1ms)

Logobelysning:

Til, med åndedrætseffekt

## Indbygget profil

Med Hyperion Fury kan du justere dine indstillinger indtil de er perfekte og gemme dem i den indbyggede hukommelse.

Du kan justere knapfunktioner, dpi-værdier, USB-rapporteringshastighed og logobelysningsstil med den valgfri Logitech Gaming Software der kan hentes fra [www.logitech.com/support/g402hyperionfury](http://www.logitech.com/support/g402hyperionfury).

## Tip

Afprøv standardindstillingerne i nogle øvespil før du ændrer dem.

Erfarne spillere kan tilpasse configurationen af knapperne og skifte følsomhed til hvert spil alt efter hvilke behov de har.

Ved automatisk registrering af spil gemmer Logitech Gaming Software disse oplysninger og anvender dem automatisk når spillet startes.

## Dpi-indikatorer

Dpi-værdier vises ved hjælp af de tre lysindikatorer der ses på tegningen. På billedet nedenfor ses hvilken dpi-værdi der vises af indikatorerne.

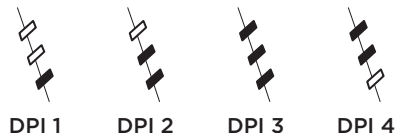

[www.logitech.com/support/g402hyperionfury](http://www.logitech.com/support/g402hyperionfury)

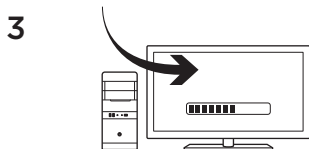
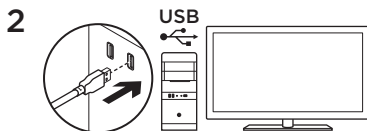
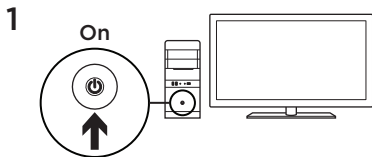

G402 Hyperion Fury er klar for å spille spill. Hvis du vil tilpasse Hyperion Fury, ser du i neste del.

Du kan tilpasse den innebygde profilen på G402 Hyperion Fury, med knappfunksjoner og sporing, ved å bruke Logitech Gaming Software. Last ned gratisprogramvaren på [www.logitech.com/support/g402hyperionfury](http://www.logitech.com/support/g402hyperionfury) for å lære hvordan du tilpasser Hyperion Fury

## 8 programmerbare knapper

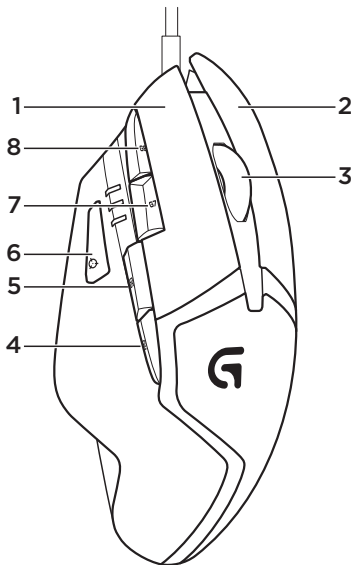

1. Venstre (knapp 1)
2. Høyre (knapp 2)
3. Hjulklikk (knapp 3)
4. Tilbake (knapp 4)
5. Fram (knapp 5)
6. Ppt-bytte (knapp G6)
7. Ppt ned (knapp G7)
8. Ppt opp (knapp G8)

### Standardinnstillinger:

Ppt-verdier: 400/800/1600/3200

Ppt-bytteverdi: 400

Usb-rapporteringshastighet:  
1000 per sekund (1 ms)

Logobelysning:

På, med pusteeffekt

## Innebygd profil

Hyperion Fury gjør det mulig å tilpasse innstillingene og deretter lagre dem i det innebygde minnet. Du kan justere knappefunksjoner, ppt-verdier, usb-rapporteringshastighet og logobelysning ved hjelp av Logitech Gaming Software, som du kan laste ned fra [www.logitech.com/support/g402hyperionfury](http://www.logitech.com/support/g402hyperionfury).

## Ppt-indikatorer

Ppt-verdier vises ved hjelp av tre LED-lamper, som vist på tegningen av musen. Bildet under viser hvilken ppt-verdi som indikeres av LED-panelet.



DPI 1



DPI 2



DPI 3



DPI 4

## Tips

Gjør deg kjent med profilinnstillingene ved å spille litt med dem før du eventuelt endrer dem.

Viderekommende spillere kan konfigurere hvert spill etter deres spesifikke knappekonfigurasjon og behov for sensitivetsbytte. I modus for automatisk oppdagelse av spill vil denne informasjonen lagres i Logitech Gaming Software, og tas automatisk i bruk hver gang den registrerer at du bruker spillet.

[www.logitech.com/support/g402hyperionfury](http://www.logitech.com/support/g402hyperionfury)



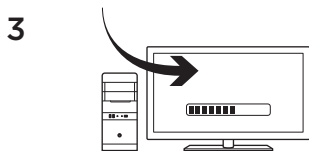
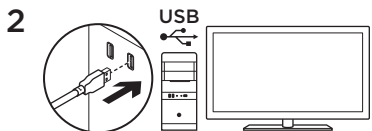
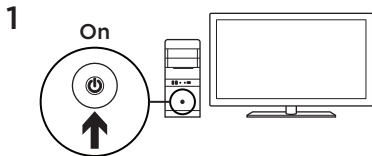

G402 Hyperion Fury on valmiina peliin. Jos haluat mukauttaa Hyperion Furyn toimintoja, katso lisätietoja seuraavasta osiosta.

Logitech Gaming Software -ohjelmiston avulla voit mukauttaa G402 Hyperion Furyn toimintaprofiilin (painikkeiden ohjelmointin ja ohjausominaisuudet). Lataa tämä ilmainen ohjelmisto ja lue Hyperion Furyn mukauttamisohjeet osoitteesta [www.logitech.com/support/g402hyperionfury](http://www.logitech.com/support/g402hyperionfury)

## 8 täysin ohjelmoitavaa painiketta

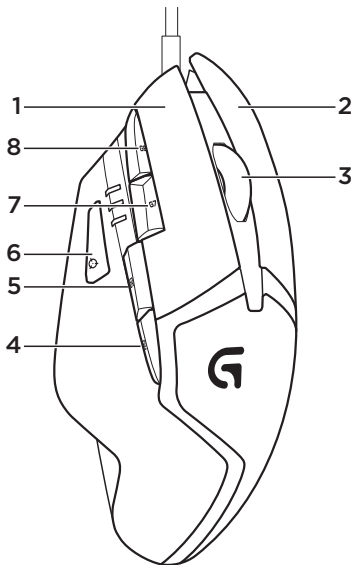

1. ykköspainike (painike 1)
2. kakkospainike (painike 2)
3. pyörän napsautus (painike 3)
4. takaisin (painike 4)
5. eteenpäin (painike 5)
6. DPI-tason vaihto (painike G6)
7. DPI-arvon vähennys (painike G7)
8. DPI-arvon lisäys (painike G8)

### Oletusasetukset:

DPI-arvot: 400, 800, 1600, 3200

DPI-vaihtoarvo: 400

USB-päivitysnopeus:

1 000 kertaa sekunnissa (1ms)

Logovalo:

käytössä, välkyntä

## Hiiren oma profiili

Hyperion Furyn asetuksia voi hienosäätää juuri sopiviksi, ja ne voi sitten tallentaa hiiren omaan muistiin. Painiketoimintoja, DPI-arvoja ja logovaloa voi säätää haluttaessa Logitech Gaming Software -ohjelmistossa, jonka voi ladata osoitteesta [www.logitech.com/support/g402hyperionfury](http://www.logitech.com/support/g402hyperionfury).

## DPI-merkkivalot

DPI-arvot ilmaistaan kolmella merkkivalolla, jotka näkyvät hiiren kaavakuvassa. Alla olevasta kuvasta näkyy, mikä DPI-arvo merkkivalojen mukaan on käytössä.



DPI 1



DPI 2



DPI 3



DPI 4

## Vihjeitä

Kokeile oletusprofiiliasetuksia harjoituspeleissä, ennen kuin muutat asetuksia.

Peliharrastajat voivat mukauttaa hiiren kuhunkin peliin sopivaksi haluamiensa painikemääritysten ja tarkkuudenvaihtotarpeidensa mukaan. Automaattisessa pelintunnistustilassa Logitech Gaming Software tallentaa tiedot ja ottaa ne automaattisesti käyttöön, kun peli tunnistetaan.

[www.logitech.com/support/g402hyperionfury](http://www.logitech.com/support/g402hyperionfury)

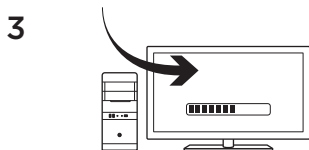
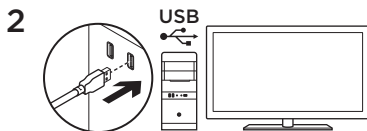
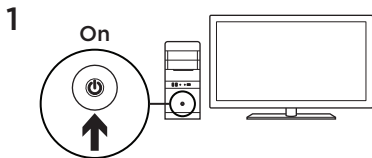

Το G402 Hyperion Fury είναι έτοιμο για παιχνίδι. Αν θέλετε να προσαρμόσετε το Hyperion Fury, ανατρέξτε στην επόμενη ενότητα.

Μπορείτε να προσαρμόσετε το ενσωματωμένο προφίλ του G402 Hyperion Fury (προγραμματισμός κουμπιών και συμπεριφορά παρακολούθησης), χρησιμοποιώντας τα λογισμικό Logitech Gaming Software. Πραγματοποιήστε λήψη αυτού του δωρεάν λογισμικού και μάθετε πώς μπορείτε να προσαρμόσετε το Hyperion Fury στη διεύθυνση [www.logitech.com/support/g402hyperionfury](http://www.logitech.com/support/g402hyperionfury)

## 8 πλήρως προγραμματιζόμενα κουμπιά

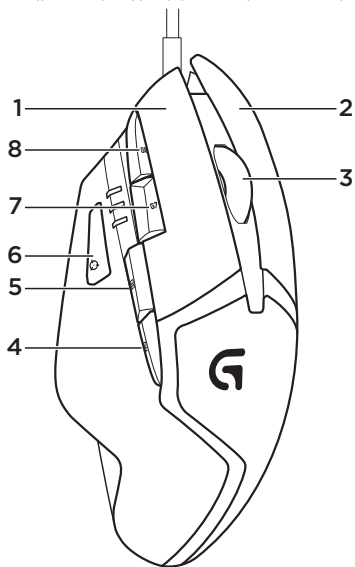

1. Αριστερό (κουμπί 1)
2. Δεξιό (κουμπί 2)
3. Πάτημα τροχού (κουμπί 3)
4. Πίσω (κουμπί 4)
5. Εμπρός (κουμπί 5)
6. Εναλλαγή DPI (κουμπί G6)
7. Μείωση DPI (κουμπί G7)
8. Αύξηση DPI (κουμπί G8)

**Προεπιλεγμένες ρυθμίσεις:**

Τιμές DPI: 400/800/1600/3200

Τιμή εναλλαγής DPI: 400

Ταχύτητα απόκρισης USB: 1000/  
δευτερόλεπτο (1 ms)

Φωτισμός λογότυπου:

Ενεργός, αναβοσβήνει αργά

## Ενσωματωμένο προφίλ

Το Hyperion Fury σας επιτρέπει να προσαρμόζετε τις ρυθμίσεις μέχρι να βρείτε τις ιδανικές και να τις αποθηκεύετε στην ενσωματωμένη μνήμη. Μπορείτε να προσαρμόσετε τις λειτουργίες των κουμπιών, τις τιμές DPI, την ταχύτητα απόκρισης USB και το στυλ φωτισμού του λογότυπου, χρησιμοποιώντας το προαιρετικό λογισμικό Logitech Gaming Software, διαθέσιμο για λήψη από τη διεύθυνση [www.logitech.com/support/g402hyperionfury](http://www.logitech.com/support/g402hyperionfury).

## Ενδεικτικές λυχνίες DPI

Οι τιμές DPI εμφανίζονται με τη χρήση των τριών LED που υποδεικνύονται στο σχεδιάγραμμα του ποντικιού. Η παρακάτω εικόνα δείχνει ποια τιμή DPI υποδεικνύεται από τον πίνακα LED.

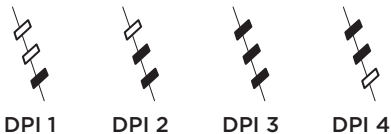

## Συμβουλές

Δοκιμάστε τις προεπιλεγμένες ρυθμίσεις προφίλ σε παιχνίδια εξάσκησης πριν αλλάξετε τις ρυθμίσεις.

Οι έμπειροι παίκτες μπορούν να προσαρμόζουν κάθε παιχνίδι με βάση τις συγκεκριμένες ανάγκες τους για τη ρύθμιση κουμπιών και την αλλαγή της ευαισθησίας. Στη λειτουργία αυτόματου εντοπισμού παιχνιδιού, το λογισμικό Logitech Gaming Software αποθηκεύει αυτές τις πληροφορίες και τις εφαρμόζει αυτόματα μόλις εντοπίσει το παιχνίδι.

[www.logitech.com/support/g402hyperionfury](http://www.logitech.com/support/g402hyperionfury)

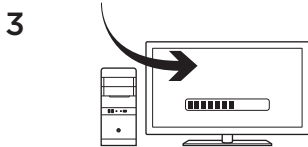
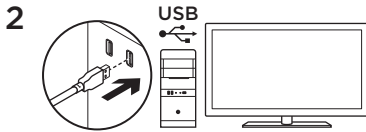
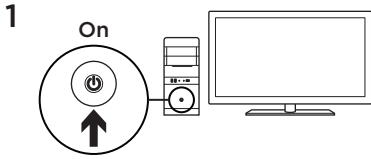

G402 Hyperion Fury'niz oyun oynamaya hazır. Hyperion Fury'nizi kişiselleştirmek istiyorsanız bir sonraki bölüme başvurun.

Logitech Gaming Software'i kullanarak, düğme programlama ve izleme davranışları dahil olmak üzere G402 Hyperion Fury'nin yerleşik profilini kişiselleştirebilirsiniz. Bu bedava yazılımı [www.logitech.com/support/g402hyperionfury](http://www.logitech.com/support/g402hyperionfury) adresinden indirin ve Hyperion Fury'yi nasıl kişiselleştirebileceğinizi öğrenin.

## 8 adet tamamen programlanabilir tuş

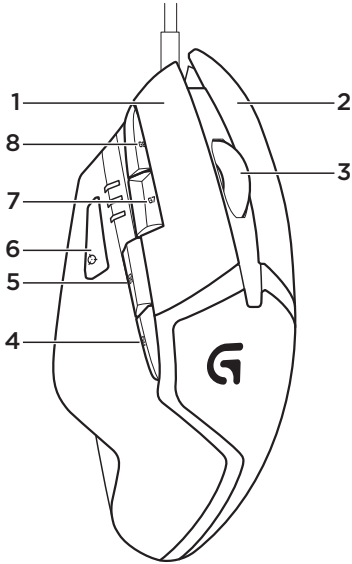

1. Sol (Düğme 1)
2. Sağ (Düğme 2)
3. Tekerlek tıklatma (Düğme 3)
4. Geri (Düğme 4)
5. İleri (Düğme 5)
6. DPI Üst karakter (Düğme G6)
7. DPI Aşağı (Düğme G7)
8. DPI Yukarı (Düğme G8)

### **Varsayılan Ayarlar:**

DPI Değerleri: 400/800/1600/3200

DPI Geçiş Değeri: 400

USB Rapor Hızı: 1000/sn (1 ms)

Logo aydınlatma:

Yanıp sönme efektiyle açık



## Yerleşik profil

Hyperion Fury ayarlarınızı mükemmel olana dek değiştirmenizi ve yerleşik belleğinde depolamanızı sağlar. Düğme fonksiyonlarını, DPI değerlerini, USB rapor hızını ve logo aydınlatma stilini [www.logitech.com/support/g402hyperionfury](http://www.logitech.com/support/g402hyperionfury) adresinden indirilebilen isteğe bağlı Logitech Gaming Software'i kullanarak ayarlayabilirsiniz.

## DPI göstergeleri

DPI değerleri mouse çiziminde belirtildiği üzere üç LED ışık kullanılarak gösterilmiştir. Aşağıdaki resim LED panelinde hangi DPI değerinin belirtildiğini göstermektedir.



DPI 1



DPI 2



DPI 3



DPI 4

## İpuçları

Bu ayarları değiştirmeden önce pratik yapabileceğiniz oyunlarla varsayılan profil ayarlarını deneyin.

İleri seviye oyuncular her oyunu kendisine özel düğme yapılandırmalarına ve hassas düğme değiştirme ihtiyaçlarına göre kişiselleştirebilirler. Otomatik oyun algılama modunda, Logitech Gaming Software bu bilgiyi depolar ve oyun algılandığı zaman otomatik olarak uygular.

[www.logitech.com/support/g402hyperionfury](http://www.logitech.com/support/g402hyperionfury)

1

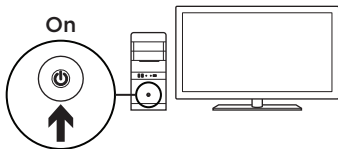

2

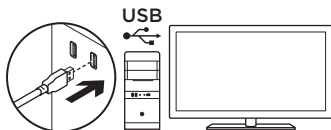

إن G402 Hyperion Fury الخاص بك جاهز للممارسة  
الألعاب عليه. إذا كنت ترغب في إضفاء سمات شخصية  
على Hyperion Fury، فراجع القسم التالي.

3

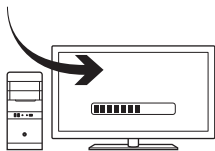

يمكنك تشخيص ملف التعريف المدمج لـ G402  
Hyperion Fury—متضمنًا برمجة الزر  
وأسلوب التتبع—باستخدام برنامج  
Logitech Gaming. قم بتنزيل هذا البرنامج المجاني وتعرف  
على كيفية تشخيص Hyperion Fury على  
الموقع [www.logitech.com/support/  
g402hyperionfury](http://www.logitech.com/support/g402hyperionfury)

## 8 زرًا قابلاً للبرمجة بالكامل

1. اليسار (الزر 1)
2. اليمين (الزر 2)
3. النقر فوق البكرة (الزر 3)
4. الرجوع (الزر 4)
5. الأمام (الزر 5)
6. تبديل حساسية DPI (الزر G6)
7. خفض حساسية DPI (الزر G7)
8. زيادة حساسية DPI (الزر G8)

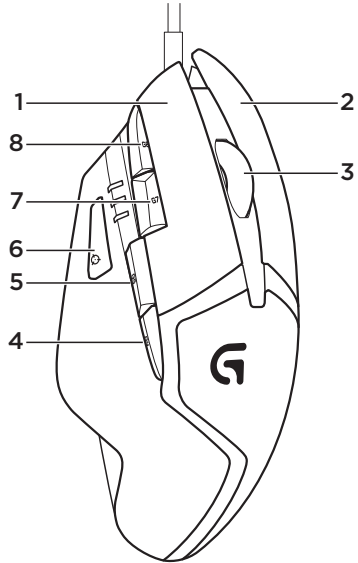

### الإعدادات الافتراضية:

قيم 3200/1600/800/DPI: 400

قيمة تبديل حساسية DPI: 400

معدل تقارير 1000/ثانية (1ملي ثانية)

إضاءة الشعار: تشغيل، مع تأثير الاستشاق

## ملف التعريف المدمج

## تلميحات

يمكنك تجربة الإعدادات الافتراضية لملف التعريف في الألعاب التجريبية قبل تغيير هذه الإعدادات. كذلك، يستطيع اللاعبون المتمرسون تخصيص كل لعبة بحسب احتياجات تغيير مستوى الحساسية والتهيئة الخاصة بالأزرار. في وضع اكتشاف الألعاب التلقائية، يقوم برنامج Logitech Gaming بتخزين هذه المعلومات وتطبيقها تلقائيًا عند اكتشاف اللعبة.

يسمح لك Hyperion Fury بإدخال التعديلات النهائية على الإعدادات لديك حتى تصبح مثالية كما يتيح لك تخزينها في ذاكرته المدمجة. يمكنك تعديل وظائف الأزرار وقيم DPI ومعدل تقرير USB ونمط إضاءة الشعار باستخدام برنامج Logitech Gaming الاختياري، المتاح تنزيله من الموقع [www.logitech.com/support/g402hyperionfury](http://www.logitech.com/support/g402hyperionfury).

## مؤشرات DPI

يتم عرض قيم DPI باستخدام مصابيح LED الثلاثة المشار إليها في الرسم التوضيحي الخاص بالماوس. توضح الصورة أدناه قيمة DPI التي تتم الإشارة إليها في لوحة مصابيح LED.

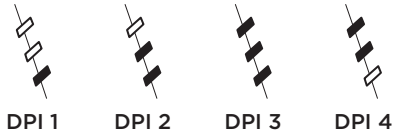

[www.logitech.com/support/g402hyperionfury](http://www.logitech.com/support/g402hyperionfury)



[www.logitech.com](http://www.logitech.com)

© 2014 Logitech. All rights reserved. Logitech, the Logitech logo, and other Logitech marks are owned by Logitech and may be registered. All other trademarks are the property of their respective owners. Logitech assumes no responsibility for any errors that may appear in this manual. Information contained herein is subject to change without notice.

621-000343.002