

**lenovo**

# Lenovo Yoga 2 11

## User Guide



Read the safety notices and important tips in the included manuals before using your computer.

## Notes

- Before using the product, be sure to read *Lenovo Safety and General Information Guide* first.
- Some instructions in this guide may assume that you are using Windows® 8. If you are using another Windows operating system, some operations may be slightly different. If you are using other operating systems, some operations may not apply to you.
- The features described in this guide are common to most models. Some features may not be available on your computer or your computer may include features that are not described in this user guide.
- The illustrations in this manual may differ from the actual product. Please refer to the actual product.

## Regulatory Notice

- For details, refer to **Guides & Manuals** at <http://support.lenovo.com>.

**First Edition (September 2013)**

**© Copyright Lenovo 2013.**

LIMITED AND RESTRICTED RIGHTS NOTICE: If data or software is delivered pursuant to a General Services Administration "GSA" contract, use, reproduction, or disclosure is subject to restrictions set forth in Contract No. GS-35F-05925.

# Contents

<b>Chapter 1. Getting to know your computer .....</b>	<b>1</b>
Top view .....	1
Left-side view .....	8
Right-side view .....	11
Bottom view .....	14
<b>Chapter 2. Starting to use Windows 8 .....</b>	<b>15</b>
Configuring the operating system for the first time .....	15
Operating system interfaces .....	15
Charms and the charms bar.....	16
Putting the computer to sleep or shutting it down .....	18
Touch screen operation .....	19
Connecting to wireless LAN .....	23
Help and support .....	24
<b>Chapter 3. Lenovo OneKey Recovery system .....</b>	<b>25</b>
<b>Chapter 4. Troubleshooting .....</b>	<b>27</b>
Frequently asked questions .....	27
Troubleshooting .....	29
<b>Trademarks.....</b>	<b>32</b>



# Chapter 1. Getting to know your computer

## ■ ■ Top view

---

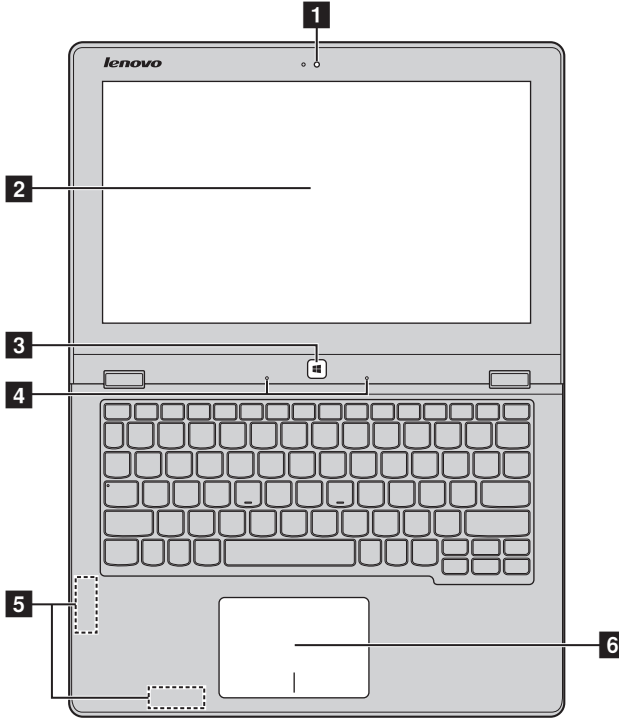

**Note:** The dashed areas indicate parts that are not visible externally.

Ⓞ **Attention:**

- When closing the display panel, be careful *not* to leave pens or any other objects in between the display panel and the keyboard. Otherwise, the display panel may be damaged.

## Chapter 1. Getting to know your computer

- 1 Integrated camera (on select models)** Use the camera for video communication.
- 2 Multi-touch screen** The LCD display with LED backlight provides brilliant visual output. Multi-touch function is available on this display.
- 3 Windows button** Press this button to:  
Toggle between the current view and the Start screen.  
*-or-*  
Wake up the computer from sleep mode.
- 4 Built-in microphones** Capture sound which can be used for video conferencing, voice narration, or audio recording.
- 5 Wireless LAN antennas** Connect to a wireless LAN adapter to send and receive wireless radio signals.
- 6 Touch pad** The touch pad functions as a conventional mouse.  
  
**Touch pad:** To move the pointer on the screen, slide your fingertip over the pad in the direction in which you want the pointer to move.  
**Touch pad buttons:** The functions of the left/right side correspond to those of the left/right mouse button on a conventional mouse.

**Note:** You can enable/disable the touch pad by pressing F6 ()

### ■ Using the keyboard

#### Keyboard function keys

You can access certain system settings quickly by pressing the appropriate function keys.

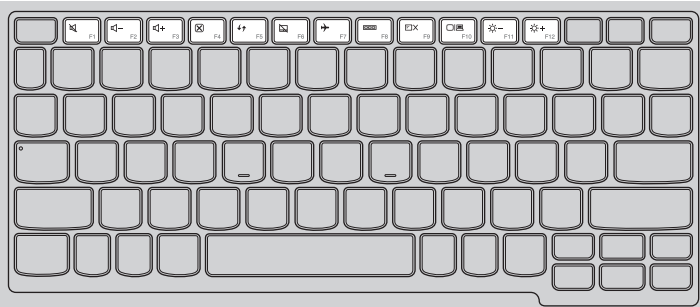

Mutes/unmutes the sound.



Enables/disables Airplane mode.



Decreases the volume level.



Displays all currently active apps.



Increases the volume level.



Turns on/off the backlight of the LCD screen.



Closes the currently active window.



Toggles the display between the computer and an external device.



Refreshes the desktop or the currently active window.



Decreases display brightness.



Enables/disables the touch pad.



Increases display brightness.

## Chapter 1. Getting to know your computer

### Function key combinations

Through the use of the function keys, you can change operational features instantly. To use this function, press and hold **Fn** **1**; then press one of the function keys **2**.

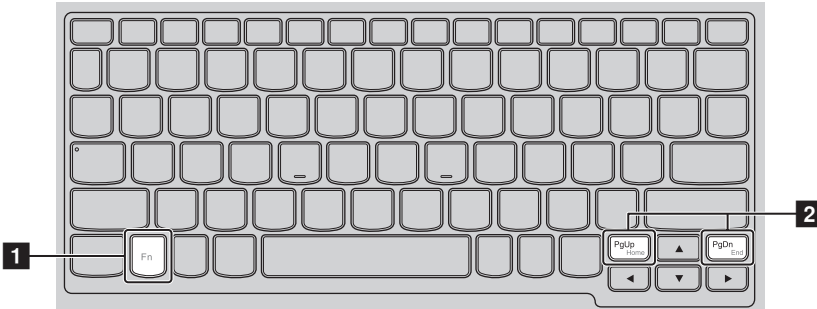

The following describes the features of each function key.

**Fn + PgUp:** Activates the pause function.

**Fn + PgDn:** Activates the break function.

**PgUp:** Enables/disables the scroll lock.

**PgDn:** Activates the insert function.



## Chapter 1. Getting to know your computer

### ■ Positioning the display panel

The display panel can be opened to any angle up to 360 degrees.



### ■ Notebook Mode



Suitable for tasks that require a keyboard and mouse (such as creating documents, writing e-mails, and so on).

## Chapter 1. Getting to know your computer

### Stand Mode (Theater Mode)



Suitable for tasks that require little or no touch (such as viewing photos or playing videos).

### Tablet Mode



Suitable for tasks that require touching the screen often (such as surfing the Web, playing games, and so on).

### Tent Mode (Presentation Mode)



Suitable for tasks that require limited interaction with the touch screen (such as displaying graphs or PowerPoint presentations).

⦿ **Attention:**

- Do *not* open the display with too much force, otherwise the panel or hinges may be damaged.

**Note:** The keyboard and touch pad are automatically locked when the screen is opened beyond 190 degrees (approximately).

## Chapter 1. Getting to know your computer

### ■ ■ Left-side view

---

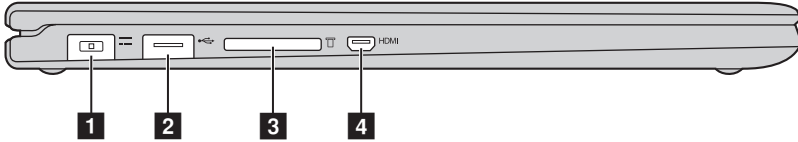

**1 AC power adapter jack** Connects to the AC power adapter.

**2 USB 3.0 port** Connects to USB devices.

**Note:** For details, see “Connecting USB devices” on page 9.

**3 Memory card slot** Insert memory cards (not supplied) here.

**Note:** For details, see “Using memory cards (not supplied)” on page 10.

**4 Micro HDMI port** Connects to devices with micro HDMI input such as a TV or an external display.

### ■ Connecting USB devices

Your computer comes with two USB ports compatible with USB devices.

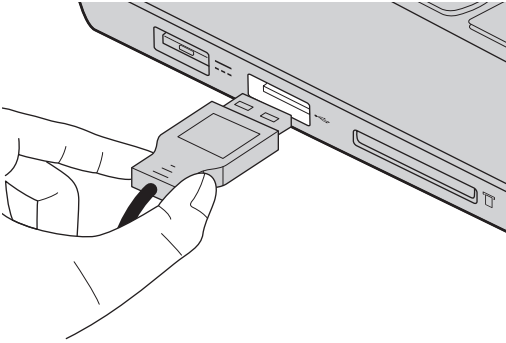

The first time you plug a USB device into a particular USB port on your computer, Windows automatically installs a driver for that device. After the driver has been installed, you can disconnect and reconnect the device without performing any additional steps.

**Note:** Typically, Windows detects a new device after it has been connected, and then installs the driver automatically. However, some devices may require you to install the driver before connecting. Check the documentation provided by the device's manufacturer before connecting the device.

Before disconnecting a USB storage device, make sure your computer has finished transferring data to that device. Click the **Safely Remove Hardware and Eject Media** icon in the Windows notification area to remove the device before disconnecting.

**Note:** If your USB device uses a power cord, connect the device to a power source before connecting it. Otherwise, the device may not be recognized.

## Chapter 1. Getting to know your computer

### ■ Using memory cards (not supplied)

Your computer supports the following types of memory cards:

- Secure Digital (SD) card
- MultiMediaCard (MMC)

**Notes:**

- Insert *only* one card in the slot at a time.
- This card reader does not support SDIO devices (e.g., SDIO Bluetooth, etc.).

### Inserting a memory card

Slide the memory card in until it clicks into place.

### Removing a memory card

- ① Push the memory card in until you hear a click.
- ② Gently pull the memory card out of the memory card slot.

**Note:** Before removing the memory card, disable it by using the Windows safely remove hardware and eject media utility to avoid data corruption.

Right-side view

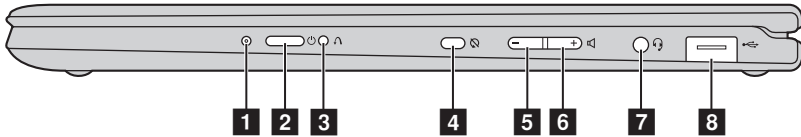

**1** Battery status indicator

**2** Power button and power status indicator

Press this button to turn on the computer.

Indicator	Indicator status	Meaning
<b>Battery status indicator</b>	On (solid white)	The battery has more than 20% charge.
	Solid amber	The battery has between 5% and 20% charge.
	Fast blinking amber	The battery has less than 5% charge.
	Slow blinking amber	The battery is being charged. When battery charge reaches 20%, the blinking color changes to white.
	Slow blinking white	The battery has between 20% and 80% charge and is still charging. When the battery reaches 80% charge the light will stop blinking, but charging will continue until the battery is fully charged.
<b>Power status indicator</b>	On (solid white)	The computer is powered on.
	Blinking	The computer is in sleep mode.
	Off	The computer is powered off.

## Chapter 1. Getting to know your computer

- 3 Novo button** When the computer is off, press this button to start the Lenovo OneKey Recovery system or the BIOS setup utility, or to enter the boot menu.
- 4 Rotation lock button** Keeps the screen locked in portrait or landscape orientation. Locking the screen rotation will disable the gravity sensing function, thereby preventing the screen from changing its orientation automatically depending upon the angle at which it is held.

**Note:** The screen rotation lock button will be disabled in notebook mode.

- 5 Volume down button** Decreases the volume level.
- 6 Volume up button** Increases the volume level.
- 7 Combo audio jack** Connects to headsets.

**Notes:**

- The combo audio jack does not support conventional microphones.
- The recording function may not be supported if third-party headphones or headsets are connected, due to different industry standards.

- 8 USB port** Connects to USB devices.

**Note:** For details, see “Connecting USB devices” on page 9.



### ■ Screen orientation

You can rotate the display panel to your preferred orientation.

- The orientation of the display automatically changes (alternating between portrait and landscape modes) depending upon how you hold the computer.

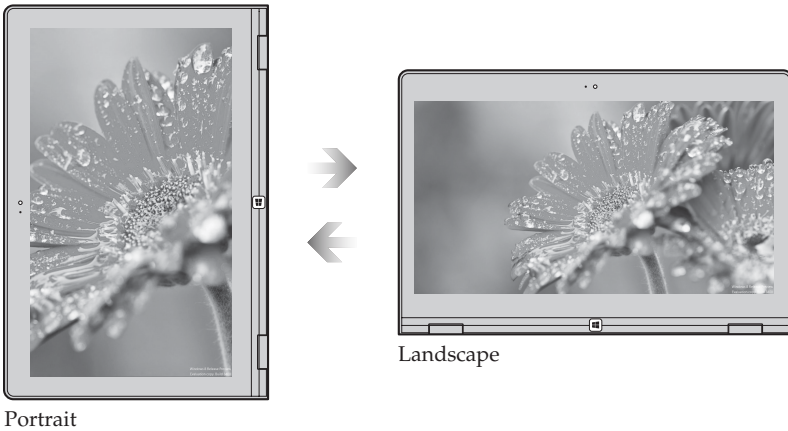

- To prevent automatic orientation, press the rotation lock button. It is located on the right edge of the computer (See illustration below).

**Note:** The screen rotation lock button will be disabled in notebook mode.

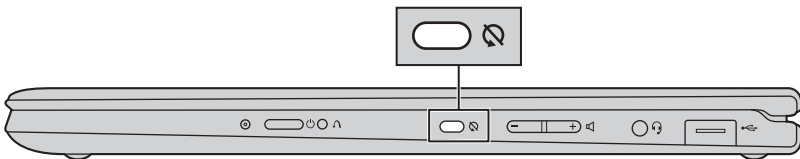

■ ■ Bottom view

---

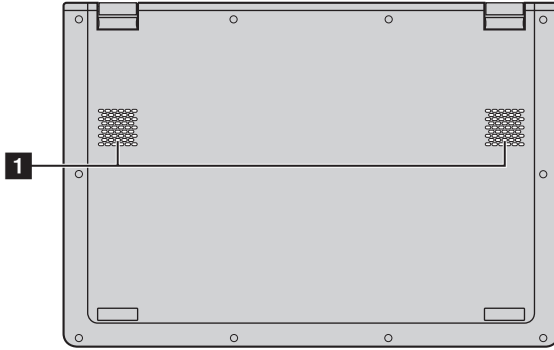

**1** Speakers

Provide audio output.

## Chapter 2. Starting to use Windows 8

### ■ ■ Configuring the operating system for the first time

---

You may need to configure the operating system when it is first used. The configuration process may include the procedures below:

- Accepting the end user license agreement
- Configuring the internet connection
- Registering the operating system
- Creating a user account

### ■ ■ Operating system interfaces

---

Windows 8 comes with two main User Interfaces: the Start screen and the desktop.

To switch from the Start screen to the desktop, do one of the following:

- Select the desktop tile on the Start screen.
- Press the Windows button.
- Press Windows key  + D.

To switch from the desktop to the Start screen, do one of the following:

- Select **Start**  from the charms.
- Move the cursor to the lower-left corner, then select the Start screen thumbnail when it is displayed.

#### Start screen

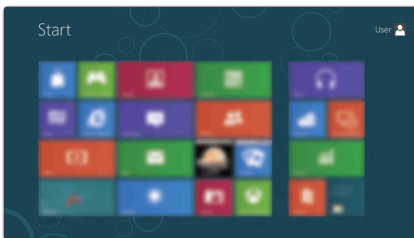

#### Desktop

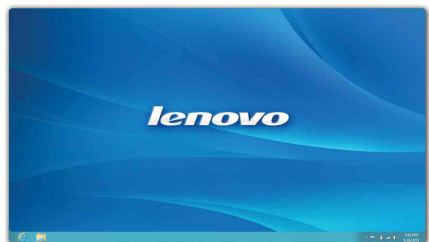

### ■ Charms and the charms bar

---

**Charms** are navigation buttons that let you access basic tasks quickly. Charms include: Search, Share, Start, Devices, and Settings. The **charms bar** is the menu that contains the charms.

To display the charms, do one of the following:

- Move the pointer to the upper-right or lower-right corner until the charms bar is displayed.
- Use one finger to swipe in from the right edge of the screen until the charms bar is displayed.
- Press Windows key  + C.

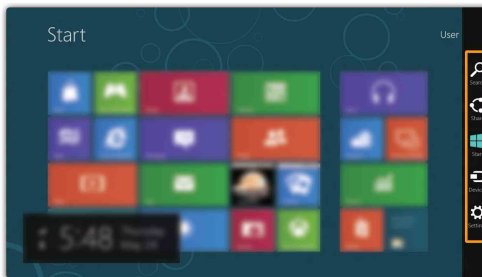

#### Search charm

The **Search** charm enables you to find whatever you are looking for, including apps, settings and files.

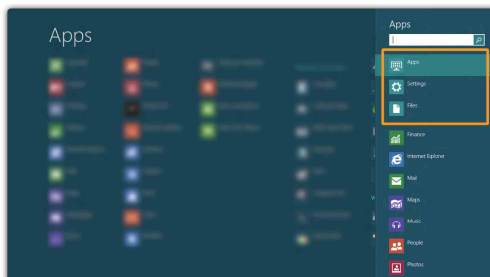

### **Share charm**

The **Share** charm lets you send links, photos, and more to your friends and social networks without leaving the app you are in.

### **Start charm**

The **Start** charm is a fast way to go to the Start screen.

### **Devices charm**

The **Devices** charm enables you to connect or send files to any external devices, such as digital cameras, TVs, printers, or projectors.

### **Settings charm**

The **Settings** charm lets you perform basic tasks, such as setting the volume or shutting down the computer. Also, you can get to the Control Panel through the **Settings** charm when using the desktop screen.

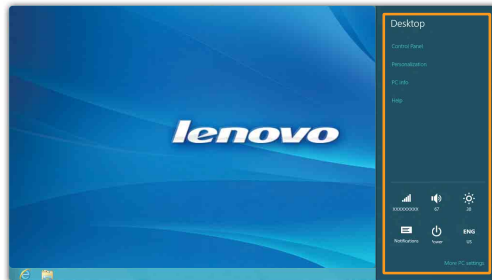

### ■ ■ Putting the computer to sleep or shutting it down

---

When you have finished working with your computer, you can put it to sleep or shut it down.

#### ■ Putting your computer to sleep

If you will be away from your computer briefly, put the computer to sleep. When the computer is in sleep mode, you can quickly wake it to resume use, bypassing the startup process.

To put the computer to sleep, do one of the following:

- Close the display panel.
- Press the Power button.
- Open the charms and then select **Settings**  → **Power**  → **Sleep**.

**Note:** Put your computer to sleep before you move it. Moving your computer while the hard disk drive is spinning can damage the hard disk, causing loss of data.

To wake the computer, do one of the following:

- Press any key on the keyboard. (Notebook mode only)
- Press the Power button.
- Press the Windows button.

#### ■ Shutting down the computer

If you are not going to use your computer for a long time, shut it down.



Open the charms, and then select **Settings**  → **Power**  → **Shut down**.

## ■ Touch screen operation

The display panel can accept inputs like a tablet, using the multi-touch screen, or like a traditional notebook computer, using the keyboard and touch pad.

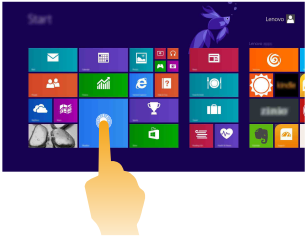

### ■ Multi-touch gestures

You can touch the screen with one or more fingertips to perform a variety of tasks.

Frequently used gestures	Tasks performed
<p><b>Tap</b> Tap once on an item.</p> 	<p>Performs an action, such as starting an app, opening a link, or performing a command. Similar to left-clicking with a mouse.</p>
<p><b>Press and hold</b> Press your finger down and leave it there for a moment.</p> 	<p>Allows you to see detailed information before selecting an action. Can also open a menu with more options. Similar to right-clicking with a mouse.</p>

## Chapter 2. Starting to use Windows 8

(continued)

Frequently used gestures	Tasks performed
<p><b>Zoom</b> Move two fingers together or apart while touching the screen.</p>  An illustration showing a hand with two fingers touching a document. Two arrows point outwards from the fingers, indicating the zooming action.	<p>Zooms in and out on visual apps, such as pictures and maps. Can also jump to the beginning or end of a list.</p>
<p><b>Rotate</b> Place two or more fingers on an item and then turn your hand.</p>  An illustration showing a hand with two fingers touching a colorful, abstract, swirling object. Two curved arrows indicate the rotation of the hand.	<p>Turns an object. (Note: Not all items can be rotated, depending upon the app.)</p>
<p><b>Slide</b> Drag your finger across the screen.</p>  An illustration showing a hand with one finger touching a stack of papers. A vertical double-headed arrow indicates the sliding motion.	<p>Pans or scrolls through lists and pages. Can also move an object or be used to draw or write, depending upon the app. Similar to pressing and holding to pan and to scrolling with a mouse.</p>

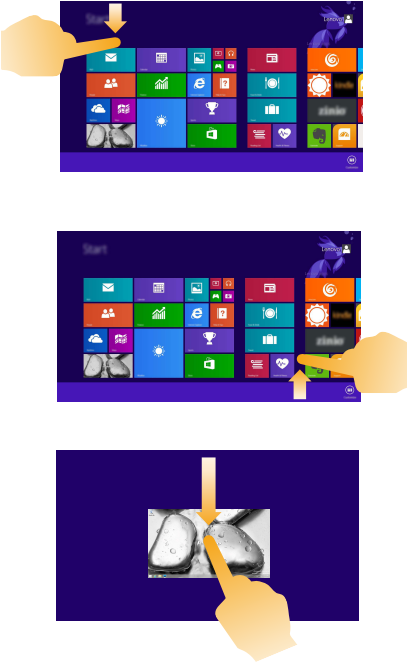

(continued)

Frequently used gestures	Tasks performed
<p><b>Swipe</b> Start from any edge of the screen, then swipe inwards toward the center.</p> 	<p>Swiping down from the top edge or up from the bottom edge displays a task bar on the bottom of the screen with app commands, including New, Refresh, and other commands.</p> <p>If you have an app currently open, you can also:</p> <ul style="list-style-type: none"> <li>• Swipe from the top edge to halfway down the screen without lifting your finger to dock that app on the left or right side of the screen. This allows you to keep two apps open simultaneously in a split-screen format.</li> <li>• Swipe from the top edge straight down to the bottom edge of the screen continuously without lifting your finger to close the currently open app.</li> </ul>

## Chapter 2. Starting to use Windows 8

(continued)

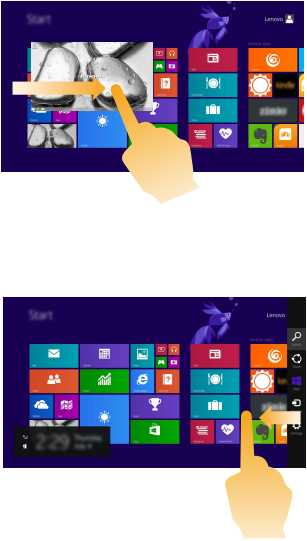
Frequently used gestures	Tasks performed
 <p>The top screenshot shows the Windows 8 Start screen with a hand icon on the left side, swiping from the left edge towards the center. A white arrow points from the left edge towards the center. The bottom screenshot shows the same Start screen with a hand icon on the right side, swiping from the right edge towards the center. A white arrow points from the right edge towards the center.</p>	<p>Swiping in from the left edge can:</p> <ul style="list-style-type: none"><li>• Bring in and open an app currently running in the background.</li></ul> <p>If there is more than one currently open app, you can:</p> <ul style="list-style-type: none"><li>• Swipe in from the left to bring in an app and, without lifting your finger, push that app quickly back off the left edge of the screen. This displays a list of the apps currently running in the background.</li></ul> <p>Swiping in from the right edge of the screen displays the charms.</p>

### ■ ■ Connecting to wireless LAN

---

#### Enabling wireless connection

To enable wireless functions, do one of the following:

- Press F7 (  ) to disable Airplane mode.
- Open the charms, select **Settings**  →  to open the Network configuration page. Toggle the Airplane mode switch to **Off**.

#### Connecting to a wireless LAN

After wireless has been enabled, the computer will automatically scan for available wireless networks and display them in the wireless LAN network list. To connect to a wireless network, click the network name in the list, and then click **Connect**.

**Note:** Some networks require a network security key or passphrase for connection. To connect to one of those networks, ask the network administrator or the Internet Service Provider (ISP) for the security key or passphrase.

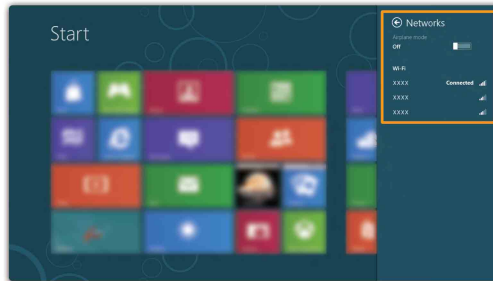

## Chapter 2. Starting to use Windows 8

### ■ ■ Help and support

---

If you have any problems using the operating system, see the Windows Help and Support file. To open the Windows Help and Support file, do one of the following:

- Select the **Settings** charm, then select **Help**.
- Press Windows key  + **Fn** + **F1**.

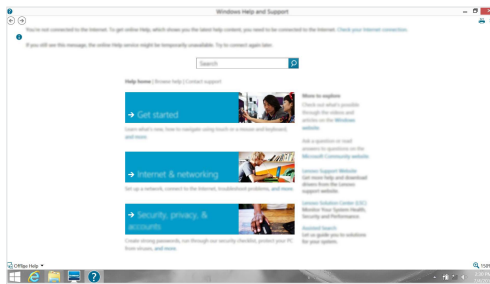

You can read the Windows Help and Support file on your computer. You can also get online help and support by clicking the link listed under **More to explore**.

## Chapter 3. Lenovo OneKey Recovery system

The Lenovo OneKey Recovery system is software designed to back up and restore your computer. You can use it to restore the system partition to its original status in case of a system failure. You can also create user backups for easy restoration as required.

### Notes:

- If your computer is preinstalled with a GNU/Linux operating system, OneKey Recovery system is not available.
- To utilize the features of the OneKey Recovery system, your hard disk already includes a hidden partition by default to store the system image file and the OneKey Recovery system program files. This default partition is hidden for security reasons, which explains why the available disk space is less than the stated capacity.

### ■ Backing up the system partition

You can back up the system partition to an image file. To back up the system partition:

- ① Press the Novo button to start the Lenovo OneKey Recovery system.
- ② Click **System Backup**.
- ③ Select a back-up location and click **Next** to start the backup.

### Notes:

- You can choose a back-up location on the local hard disk drive or an external storage device.
- Remove the removable hard disk drive before starting the Lenovo OneKey Recovery system. Otherwise, data from the removable hard disk drive might be lost.
- The back-up process may take a while.
- The back-up process is only available when Windows can be started normally.

### ■ Restoring

You can choose to restore the system partition to its original status or to a previously created back-up point. To restore the system partition:

- ① Press the Novo button to start the Lenovo OneKey Recovery system.
- ② Click **System Recovery**. The computer will restart to the recovery environment.

## Chapter 3. Lenovo OneKey Recovery system

- 3 Follow the on-screen instructions to restore the system partition to its original status or to a previously created back-up point.

### Notes:

- The recovery process is irreversible. Make sure to back up any data you wish to save on the system partition before starting the recovery process.
- The recovery process may take a while. So be sure to connect the AC power adapter to your computer during the recovery process.
- The above instructions should be followed when Windows can be started normally.

If Windows cannot be started, then follow the steps below to start the Lenovo OneKey Recovery system:

- 1 Shut down the computer.
- 2 Press the Novo button. From the **Novo Button Menu**, select **System recovery** and press Enter.

# Chapter 4. Troubleshooting

## ■ ■ Frequently asked questions

---

This section lists frequently asked questions by category.

### ■ Finding information

#### **What safety precautions should I follow when using my computer?**

The *Lenovo Safety and General Information Guide* which came with your computer contains safety precautions for using your computer. Read and follow all the precautions when using your computer.

#### **Where can I find the hardware specifications for my computer?**

You can find hardware specification for your computer on the printed flyers which came with your computer.

#### **Where can I find warranty information?**

For the warranty applicable to your computer, including the warranty period and type of warranty service, see the Lenovo limited warranty flyer that came with your computer.

### ■ Drivers and preinstalled software

#### **Where are the installation discs for Lenovo preinstalled software (desktop software)?**

Your computer did not come with installation discs for Lenovo preinstalled software. If you need to reinstall any preinstalled software, you can find the installation program on the D partition of your hard disk. If you cannot find the installation program there, you can also download it from the Lenovo consumer support website.

#### **Where can I find drivers for the various hardware devices of my computer?**

If your computer is preinstalled with a Windows operating system, Lenovo provides drivers for all the hardware devices that you need on the D partition of your hard disk. You can also download the latest device drivers from the Lenovo consumer support website.

### ■ Lenovo OneKey Recovery system

#### **Where are the recovery discs?**

Your computer did not come with recovery discs. Use the Lenovo OneKey Recovery system if you need to restore the system to its factory status.

## Chapter 4. Troubleshooting

### What can I do if the back-up process fails?

If you can start the backup but it fails during the back-up process, try the following steps:

- ❶ Close all open programs, and then restart the back-up process.
- ❷ Check to see if the destination media is damaged. Select another path and then try again.

### When do I need to restore the system to its factory status?

Use this feature when the operating system fails to start up. If there is critical data on the system partition, back it up before starting recovery.

## ■ BIOS setup utility

### What is the BIOS setup utility?

The BIOS setup utility is ROM-based software. It displays basic computer information and provides options for setting boot devices, security, hardware mode, and other preferences.

### How can I start the BIOS setup utility?

To start the BIOS setup utility:

- ❶ Shut down the computer.
- ❷ Press the Novo button and then select **BIOS Setup**.

### How can I change the boot mode?

There are two boot modes: **UEFI** and **Legacy Support**. To change the boot mode, start the BIOS setup utility and set boot mode to **UEFI** or **Legacy Support** on the boot menu.

### When do I need to change the boot mode?

The default boot mode for your computer is **UEFI** mode. If you need to install a legacy operating system, such as Windows, Linux or Dos, etc (that is, any operating system before Windows 8) on your computer, you must change the boot mode to **Legacy Support**. The legacy operating system, such as Windows, Linux or Dos, etc cannot be installed if you don't change the boot mode.

## ■ Getting help

### How can I contact the customer support center?

See “Chapter 3. Getting help and service” in the *Lenovo Safety and General Information Guide*.



### ■ ■ Troubleshooting

#### Display problems

When I turn on the computer, nothing appears on the screen.

- If the screen is blank, make sure that:
  - The AC power adapter is connected to the computer, and the power cord is plugged into a working electrical outlet.
  - The computer power is on. Press the Power button again for confirmation.
- If these items are set correctly, and the screen remains blank, have the computer serviced.

When I turn on the computer, only a white cursor appears on a blank screen.

- Restore backed-up files to your Windows environment or the entire contents of your hard disk to its original factory contents using the Lenovo OneKey Recovery system. If you still see only the cursor on the screen, have the computer serviced.

The screen goes blank while the computer is on.

- Your power management is enabled. Do one of the following to resume from sleep mode:
  - Press any key on the keyboard. (Notebook mode only)
  - Press the Power button.
  - Press the Windows button.
  - Press **F9** () to confirm whether the backlight of the LCD screen has been turned off.

#### Sleep problems

The critical low-battery error message appears, and the computer immediately turns off.

- The battery power is getting low. Connect the AC power adapter to the computer.

The computer enters sleep mode immediately after Power-on.

- Make sure that:
  - The battery is charged.
  - The operating temperature is within the acceptable range. See "Chapter 2. Use and care Information" in the *Lenovo Safety and General Information Guide*.

**Note:** If the battery is charged and the temperature is within range, have the computer serviced.



## Chapter 4. Troubleshooting

The computer does not return from sleep mode and the computer does not work.

- If your computer is in sleep mode, connect the AC power adapter to the computer, then press the Windows button or the Power button.
- If the system still does not return from sleep mode, your system has stopped responding, and you cannot turn off the computer; reset the computer. Unsaved data may be lost. To reset the computer, press and hold the Power button for eight seconds or more. If the computer still does not reset, remove the AC power adapter.

### Display panel problems

The screen is blank.

- Do the following:
  - If you are using the AC power adapter or the battery, and the battery status indicator is on, press **F12** () to make the screen brighter.
  - If the power indicator is blinking, press the Power button to resume from sleep mode.
  - Press **F9** () to confirm whether the backlight of the LCD screen has been turned off.
  - If the problem persists, follow the solution in the next problem "The screen is unreadable or distorted."

The screen is unreadable or distorted.

- Make sure that:
  - The screen resolution and color quality are correctly set.
  - The monitor type is correct.

Incorrect characters appear on the screen.

- Is the operating system or programs installed correctly? If they are installed and configured correctly, have the computer serviced.

### Sound problems

No sound can be heard from the speakers even when the volume is turned up.

- Make sure that:
  - The Mute function is off.
  - The combo audio jack is not being used.
  - Speakers are selected as the playback device.

### Battery problems

Your computer shuts down before the battery status indicator shows empty.

-or-

Your computer operates after the battery status indicator shows empty.

- Recharge the battery.

### Other problems

Your computer does not respond.

- To turn off your computer, press and hold the Power button for eight seconds or more. If the computer still does not respond, remove the AC power adapter.
- Your computer might lock when it enters sleep mode during a communication operation. Disable the sleep timer when you are working on the network.

The connected external device does not work.

- Do *not* connect or disconnect any external device cables other than USB while the computer power is on. Otherwise, you might damage your computer.
- When using high power consumption external devices, such as an external USB optical disk drive, use an external device power adapter. Otherwise, the device may not be recognized, or the system may shut down as a result.

# Trademarks

The following terms are trademarks or registered trademarks of Lenovo in the United States, other countries, or both.

Lenovo

OneKey

Microsoft and Windows are trademarks of Microsoft Corporation in the United States, other countries, or both.

Other company, products, or service names may be trademarks or service marks of others.



***lenovo***<sup>®</sup>

©Lenovo China 2013

en-US  
Rev. AA00