

KVR48S40BS8K2-32

32GB (16GB 1Rx8 2G x 64-Bit x 2 pcs.)
PC5-4800 CL40 262-Pin SODIMM Kit

DESCRIPTION

This document describes ValueRAM's KVR48S40BS8K2-32 is a kit of two 2G x 64-bit (16GB) DDR5-4800 CL40 SDRAM (Synchronous DRAM), 1Rx8, memory module, based on eight 2G x 8-bit FBGA components. Total kit capacity is 32GB. The SPD is programmed to JEDEC standard latency DDR5-4800 timing of 40-39-39 at 1.1V. Each 262-pin SODIMM uses gold contact fingers. The electrical and mechanical specifications are as follows:

FEATURES

- Power Supply: VDD = 1.1V Typical
- VDDQ = 1.1V Typical
- VPP = 1.8V Typical
- VDDSPD = 1.8V to 2.0V
- On-Die ECC
- PCB: Height 1.18" (30.00mm)
- RoHS Compliant and Halogen-Free

SPECIFICATIONS

CL(IDD)	40 cycles
Row Cycle Time (tRCmin)	48ns(min.)
Refresh to Active/Refresh Command Time (tRFCmin)	295ns(min.)
Row Active Time (tRASmin)	32ns(min.)
UL Rating	94 V - 0
Operating Temperature	0° C to +85° C
Storage Temperature	-55° C to +100° C

Continued >>

MODULE DIMENSIONS

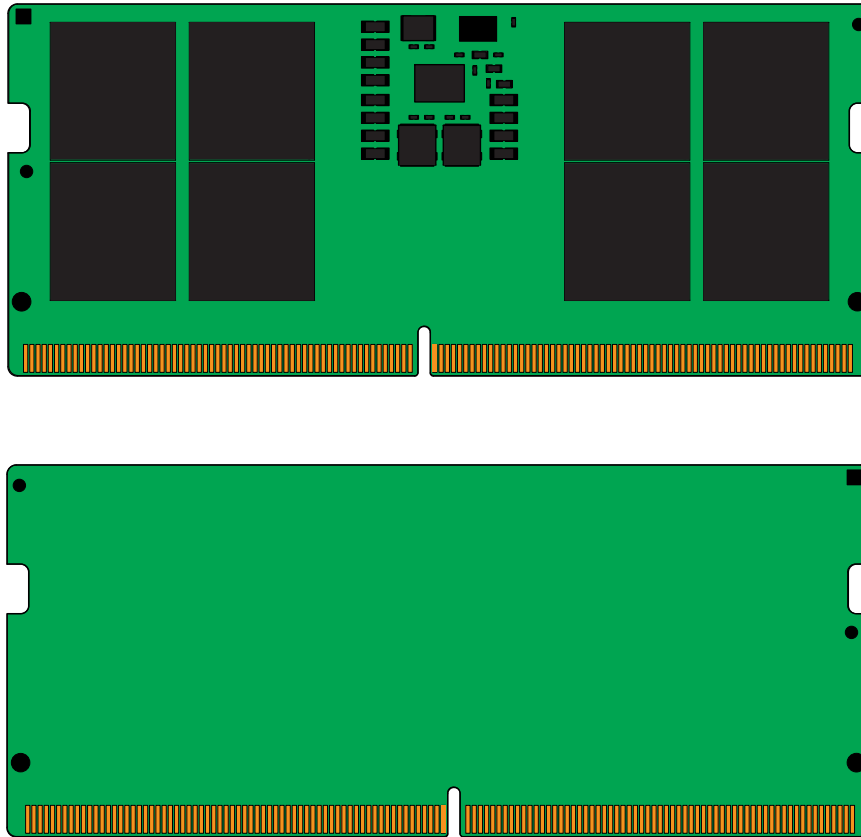

All measurements are in millimeters.
(Tolerances on all dimensions are ± 0.12 unless otherwise specified)

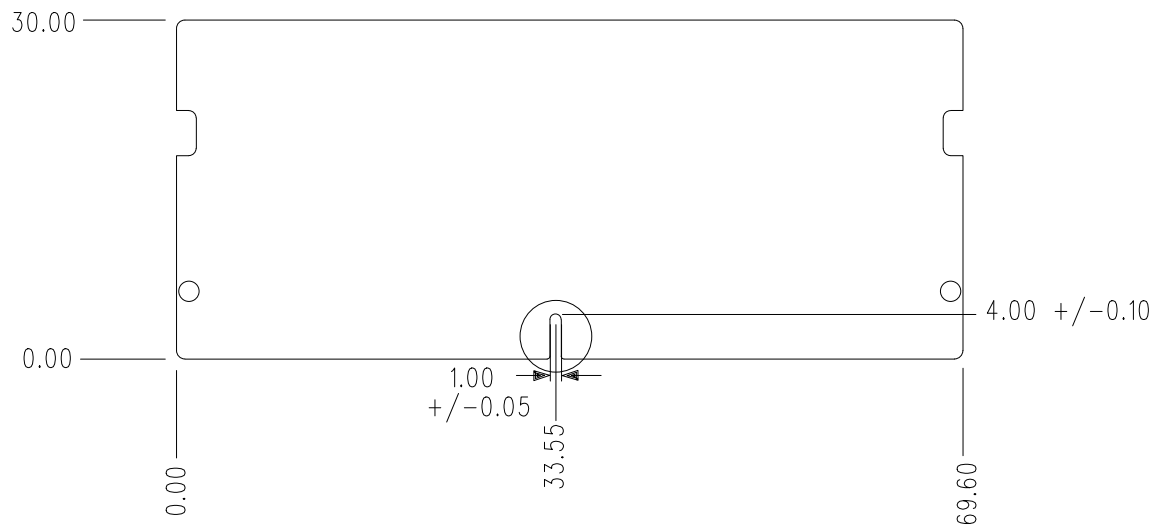

The product images shown are for illustration purposes only and may not be an exact representation of the product.
Kingston reserves the right to change any information at anytime without notice.