



User Manual

Mobile Wi-Fi Hotspot 21 Mbps

Preface

D-Link reserves the right to revise this publication and to make changes in the content hereof without obligation to notify any person or organization of such revisions or changes.

Manual Revisions

Revision	Date	Description
1.0	July 09, 2014	• Initial release
2.0	July 11, 2014	• change model description

Trademarks

D-Link and the D-Link logo are trademarks or registered trademarks of D-Link Corporation or its subsidiaries in the United States or other countries. All other company or product names mentioned herein are trademarks or registered trademarks of their respective companies.

Copyright © 2014 by D-Link Corporation, Inc.

All rights reserved. This publication may not be reproduced, in whole or in part, without prior expressed written permission from D-Link Corporation, Inc.

Table of Contents

Preface	i	Home.....	15
Manual Revisions.....	i	Wizard.....	16
Trademarks	i	Internet.....	18
Product Overview	1	Connection	18
Package Contents.....	1	2G/3G Modem	20
System Requirements.....	1	SIM	21
Introduction	2	PLMN.....	22
Hardware Overview.....	3	Network	23
Left Side.....	3	Wi-Fi.....	24
OLED Display.....	4	DHCP	25
Installation	6	NAT.....	26
Connect to Your Network	6	SMS.....	28
Insert a microSD Card	6	New Message	28
Driver Installation	7	Local	28
Wireless Installation Considerations.....	8	Wi-Fi.....	29
Configuration	9	Basic.....	29
Initial Connection to the Router	9	Wireless Security	31
Connect via USB.....	9	Wired Equivalent Privacy (WEP)	31
Connect via Wi-Fi	10	Wi-Fi Protected Access (WPA).....	32
Web-based Configuration	12	WLAN Authentication and Privacy Infrastructure	
Configuration Utility	12	(WAPI).....	33
Home	13	Wi-Fi Protected Setup (WPS)	34
Navigation.....	13	MAC Filter	35
Device Status.....	14	Station Lists.....	36
		Security	37
		Firewall	37

IP Filter	37	Networking Basics	70
IPv6 Filter	38	Check your IP address	70
MAC Filter	39	Statically Assign an IP address	71
DDOS	40	Technical Specifications	72
URL Filter	41	Warnings and Declarations	73
Application	42		
About	42		
Configuration	43		
Firmware Upgrade.....	44		
Standby Mode	45		
Password.....	46		
Date and Time	47		
Language.....	49		
System Log.....	50		
Connecting to a Wireless Network	51		
Using Windows 8.1/8.0	51		
Using Windows 7	53		
Configuring Wireless Security	55		
Using Windows Vista™	58		
Configuring Wireless Security	59		
Using Windows® XP	61		
Configure WEP	62		
Configure WPA-PSK.....	64		
Using Mac OS	66		
Troubleshooting	68		

Product Overview

Package Contents



D-Link DWR-730 Mobile Wi-Fi Hotspot 21 Mbps



Battery



USB Cable

If any of the above items are missing from your package, please contact your reseller.

System Requirements

- A compatible (U)SIM card with mobile data service¹
- A computer with Windows®, Macintosh®, or Linux-based operating systems
- Internet Explorer 8, Firefox 12.0, Chrome 20.0, or Safari 4.0

¹ Subject to services and service terms available from your carrier.

Introduction

The D-Link DWR-730 Mobile Wi-Fi Hotspot 21 Mbps lets you share a fast mobile Internet connection with multiple PCs and mobile devices wherever you go. It offers 3G HSPA+ compatibility for fast downlink and uplink data rates, so you get the high-speed upload and download speeds even when you're on the go. Set up a personal mobile network anywhere, anytime allowing you and those around you to access the Internet, and share files.

High-Speed Mobile Internet with 3G Connectivity

The DWR-730 Mobile Wi-Fi Hotspot 21 Mbps gives you high-speed access to the Internet wherever you are and lets you share it on the go. Using HSPA+ technology, you can achieve download speeds of up to 21.6 Mbps and upload speeds of up to 5.76 Mbps¹. The built-in 3G antenna provides a reliable connection to your 3G service provider, and a separate Wi-Fi antenna gives extended coverage to the computers and mobile devices connected to the DWR-730.

Mobile Internet for All of Your Devices

The Mobile Wi-Fi Hotspot 21 Mbps lets you share your fast mobile connection over Wi-Fi from a device small enough to fit in your pocket. With the DWR-730, you can get online with your notebook, smartphone, tablet, or any other wireless device using a single 3G mobile connection. The DWR-730 provides high-speed Wireless N coverage to give high-speed wireless access to everybody – whether you are with colleagues on a business trip, or travelling with friends and family.

Built-in Software for Instant Access Anywhere

The DWR-730 is truly plug and play, with drivers built right into the router so you can connect without the need to install anything. Open a browser, connect the router, and you can set up your network right from a web interface. This means that notebooks and netbooks without a CD-ROM drive can connect and get up and running in no time. Once the device is set up, you can simply power it on to start up your portable mobile network, meaning that you can share your mobile Internet connection without even needing a computer.

Designed for True Portability

The DWR-730 Mobile Wi-Fi Hotspot 21 Mbps is small and slim enough to carry around in your purse, bag, or pocket. It features a microSD card slot for optional removable storage (up to 32 GB), allowing you to always have your files and contacts on hand. The built-in 2380 mAh rechargeable Li-Ion battery can provide up to six hours of mobile usage, meaning that you can share your mobile Internet connection in the car, in the park, or anywhere, and work or play longer without needing to recharge.

¹ All references to speed are for comparison purposes only. Actual speeds will vary depending on a range of factors including mobile network coverage, signal strength, network activity, and environmental conditions.

Hardware Overview

Left Side

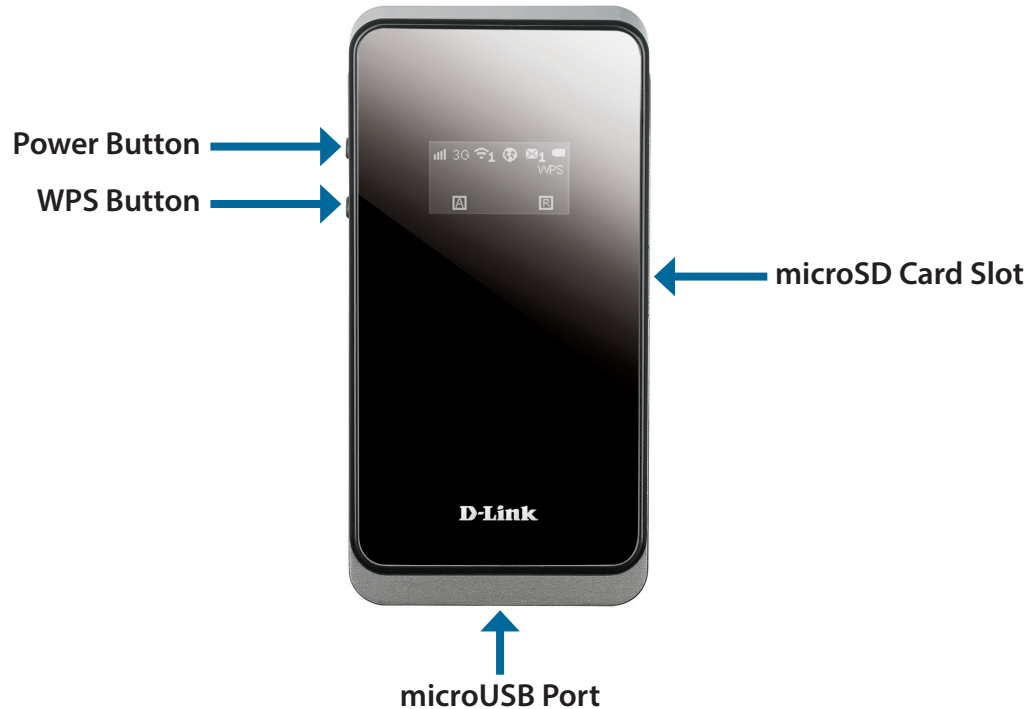

Power Button	Press and hold this button for 6 seconds to power on/off the device.
WPS Button	Press this button to add new wireless devices quickly and easily using Wi-Fi Protected Setup (WPS). Press and hold for more than 5 seconds to turn the wireless function on/off.
microSD Card Slot	Insert a microSD Card (up to 32GB) to access and share files and media wherever you go.
micro USB Connector	Use the included cable to connect to a powered USB port to charge the device, or to access the configuration utility.

Hardware Overview

OLED Display

The current status of the DWR-730's functions including mobile network, Wi-Fi, security, Internet status, signal strength, and battery level will be shown on the OLED display. Please refer to the table below for the specific indications which are shown on the display.

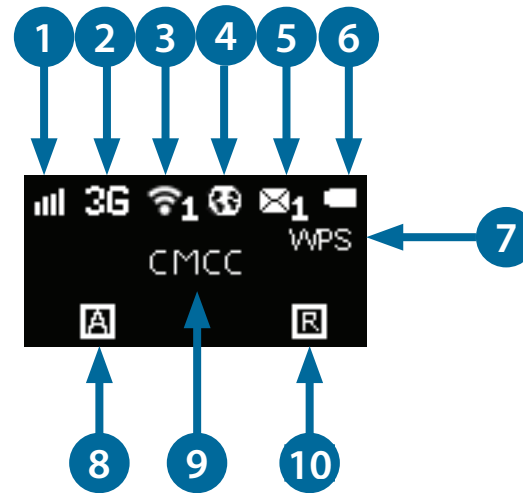

Number	Function	Icon	Indication
1	Network Strength	0-5 Bars	Indicates the strength of the current mobile network connection
2	Network Type	H+	Currently connected to DC-HSPA or HSPA+ mobile network
		H	Currently connected to HSPA mobile network
		3G	Currently connected to WCDMA mobile network
		2G	Currently connected to GPRS/EDGE network
		No SIM	No SIM card detected in device

3	Wi-Fi & Clients		Indicates that the Wi-Fi network is currently tuned on
		Number	Indicates the number of clients currently connected to the device by Wi-Fi
4	Internet Connection Status	Internet	If this icon is displayed, there is an Internet connection present
5	SMS	Number	There are unread SMS messages in the inbox
6	Battery Status	Empty-Full	Displays the current battery level. If charging, the animation will indicate charging status and current battery level
7	Wi-Fi Protected Setup	WPS	The device is ready for WPS association with wireless clients
8	Connection Method	A	The device is set to connect to the mobile network automatically
		M	The device is set to connect to the mobile network manually
		D = On Demand	The device will connect to the preferred mobile network when internet access is required.
9	Operator	Name	The name of the mobile network operator to which device is currently connected
10	Roaming	R	The device is currently roaming on a network other than the home network

Installation

This section will guide you through the installation process.

Connect to Your Network

1. Ensure that your DWR-730 Mobile Wi-Fi Hotspot 21 Mbps is powered off.
2. Remove the back cover and take out the battery. Slide your (U)SIM card into the slot provided, ensuring that the alignment is the same as indicated by the logo next to the slot. The gold contacts on the card should be facing downwards.

Caution: Always unplug and turn off the router before installing or removing the SIM card. Never insert or remove the SIM card while the router is in use.

3. Press and hold the power button on the side of the router.
 - a. "D-Link" will be displayed on the screen as the router performs its initialization processes.
 - b. After a few moments, the OLED display will show the current status of the router's various functions. For more details on the OLED display, please refer to "OLED Display" on page 4.

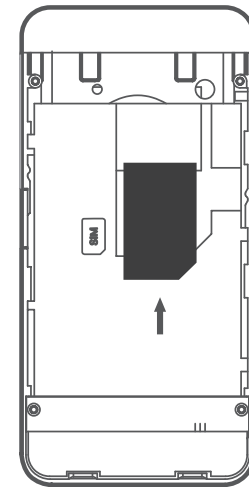

Insert a microSD Card

1. Ensure that your DWR-730 Mobile Wi-Fi Hotspot 21 Mbps is powered off.
2. Open the cover of the microSD slot on the side of the router.
3. Insert the microSD card into the slot and push it in until it locks into place.

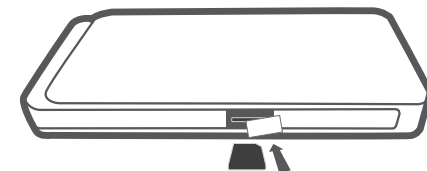

Driver Installation

When you plug the DWR-730 into your computer, any necessary drivers will immediately install (with your permission).

Note: These drivers are Windows-only. Mac and Linux users will still be able to configure the DWR-730 using the web configuration utility described in “Configuration Utility” on page 12.

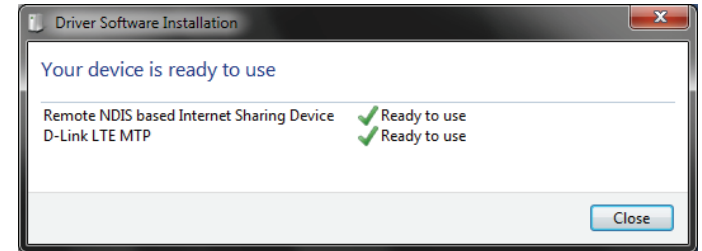

Wireless Installation Considerations

The DWR-730 can be accessed using a wireless connection from anywhere within the operating range of its wireless network. Keep in mind that the quantity, thickness, and location of walls, ceilings, or other objects that the wireless signals must pass through may adversely affect wireless signals. Ranges vary depending on the types of materials and background RF (radio frequency) noise in your home or office. The key to maximizing the wireless range is to follow these basic guidelines:

1. Minimize the number of walls and ceilings between the router and other network devices. Each wall or ceiling can reduce your adapter's range from 3 to 90 feet (1 to 30 meters).
2. Be aware of the direct line between network devices. A wall that is 1.5 feet thick (0.5 meters) appears to be almost 3 feet (1 meter) thick at a 45-degree angle. At a 2-degree angle it appears over 42 feet (14 meters) thick. Position devices so that the signal will travel straight through a wall or ceiling (instead of at an angle) for better reception.
3. Try to position access points, wireless routers, and computers so that the signal passes through open doorways and drywall. Materials such as glass, metal, brick, insulation, concrete, and water can affect wireless performance. Large objects such as fish tanks, mirrors, file cabinets, metal doors, and aluminum studs may also have a negative effect on range.
4. If you are using a 2.4 GHz cordless phone, make sure that the 2.4 GHz phone base is as far away from your wireless device as possible. The base transmits a signal even if the phone is not in use. In some cases, cordless phones, X-10 wireless devices, and electronic equipment such as ceiling fans, fluorescent lights, and home security systems may dramatically degrade wireless connectivity.

Configuration

This section will show you how to configure your new D-Link mobile router using the configuration utility that can be obtained through a software interface or a web-based user interface.

Initial Connection to the Router

When configuring the router for the first time, you will need to establish a direct connection with the router in order to access the web-based configuration utility. This can be done using the included USB cable, or by connecting wirelessly to the DWR-730. Once you have configured your router, you will be able to connect using the Wi-Fi settings that you have specified in the configuration process. Ensure that the router is powered on and has sufficient battery power before commencing the setup process.

Connect via USB

To connect to the router via USB, plug the provided micro USB cable into the micro USB port on the bottom of the router, and plug the other end into an available USB port on your computer. Your router is now ready for configuration, please refer to “Configuration Utility” on page 12 to continue the setup process.

Connect via Wi-Fi

Note: The following example uses Windows 7's built-in wireless connection utility. If you are using a different operating system, or a third party connection utility, the process may be different. Please refer to the documentation that came with your operating system or wireless client for further information on how to connect to a wireless network.

To connect to the router using Wi-Fi, open your operating system's wireless networking utility and scan for available networks to connect to. By default, the network name (SSID) of the DWR-730 will be in the format **dlink_DWR-730xxxx**, where "xxxx" represents the last four character's of the router's MAC address.



Once you have located this network with your wireless utility, connect to the network using your wireless networking utility.

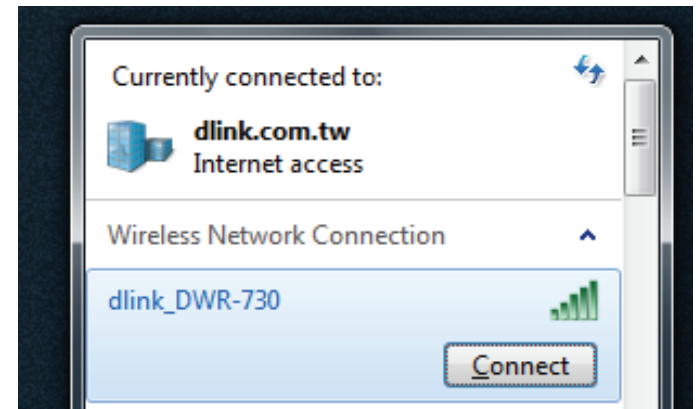

You will then be prompted to enter the network security key for your router. The unique security key for your router will be displayed on a sticker in the router's battery bay. Enter the security key in the box provided and click **OK**. Your wireless connection utility should confirm that the connection is successful, and you can move to the next step to continue to configuration process.

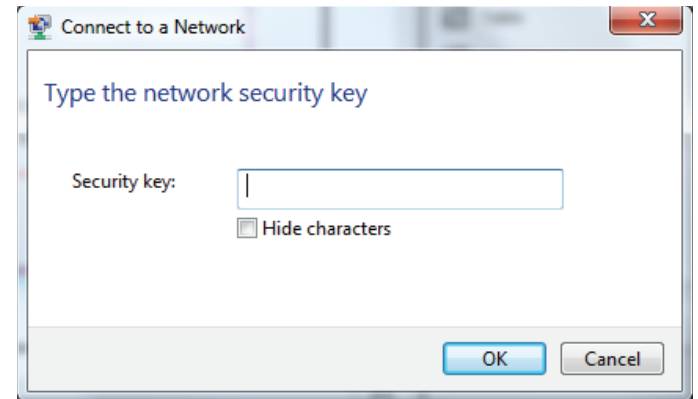

Web-based Configuration

To access the configuration utility, open a web browser (such as Internet Explorer) and enter the IP address of the router, which is **192.168.0.1** by default.

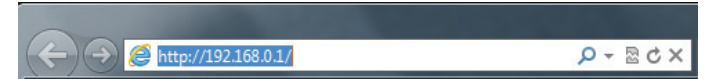

Configuration Utility

Once you have reached the configuration utility through the installed software or your web browser, you will need to log in. Enter **admin** as the username, and then enter the password. By default, the password is blank. You can also select your language from the drop-down menu.

Click **Login** to continue.

A screenshot of the D-Link login page. The page has a light blue background. On the left, there is a "Login" section with three input fields: "Account", "Password", and "Language". The "Language" field is a drop-down menu currently set to "English". Below these fields is a blue "Login" button. On the right side of the page, the "D-Link" logo is displayed in a large, bold, black font.

Home Navigation

Throughout the interface you will find a menu bar at the top of the page which includes tabs for easy navigation, and a summary bar in the upper right corner with a quick view of essential information.



Home The **Home** tab will return you the home page, where a summary of the system information is shown.

Wizard: Click on this tab to start the setup wizard, which will guide you through the basic setup process.

Internet: The **Internet** tab gives you Internet setup and settings options.

Network: The **Network** tab allows you to configure the network settings for your Local Area Network (LAN).

SMS: From the **SMS** you can view and send SMS messages via your mobile network.

Wi-Fi: The **Wi-Fi** allows you to configure your Wi-Fi network, as well as add new devices using WPS.

Security: The **Security** tab allows you to configure firewall and security settings to protect your network from WAN-side intrusions.

Application: From this tab, you can manage the administrative configuration of your router, such as time and date, firmware, language, and remote management.

Device Status

A summary of the device's current status will be displayed on the information panel at the top of the right-hand side of the navigation bar. The following is a description of the indications, from left to right.

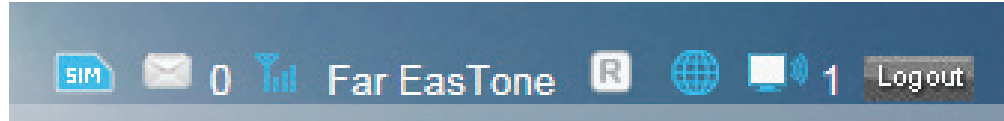

SIM: This icon shows whether or not a compatible (U)SIM card has been inserted into the device.

SMS: The number to the right of this icon indicates the number of unread messages in the SMS inbox.

Signal Strength: Indicates the current strength of the mobile network signal being received.

Operator Name: The name of the mobile network operator to which the device is currently connected.

Roaming: Indicates that the device is connected to a network other than your service provider's home network.

Internet: Indicates that there is an Internet connection present.

Wi-Fi Network: Indicates that the router's Wi-Fi network is currently active. The number to the right of this icon indicates the number of wireless clients currently connected to the router's Wi-Fi network.

Logout: Click this button to log out of the configuration interface.

Home

The **Home** page acts as a dashboard to quickly display your configuration settings and provide a summary of the current status of your network's status.

System Resources: This area displays the percentage of the router's memory and CPU currently being used by the system.

LAN: This area displays a summary of the current settings for the router's LAN.

2G/3G Modem: This area shows the current status of your 2G or 3G mobile network connection.

WAN: This area displays a summary of the router's current WAN settings. These details will reflect the mobile network connection which is being received from the service provider.

Traffic Statistics: This area shows the amount of data which has been sent (TX) and received (RX) over the mobile network. This information may not reflect the amount recorded by your mobile service provider.

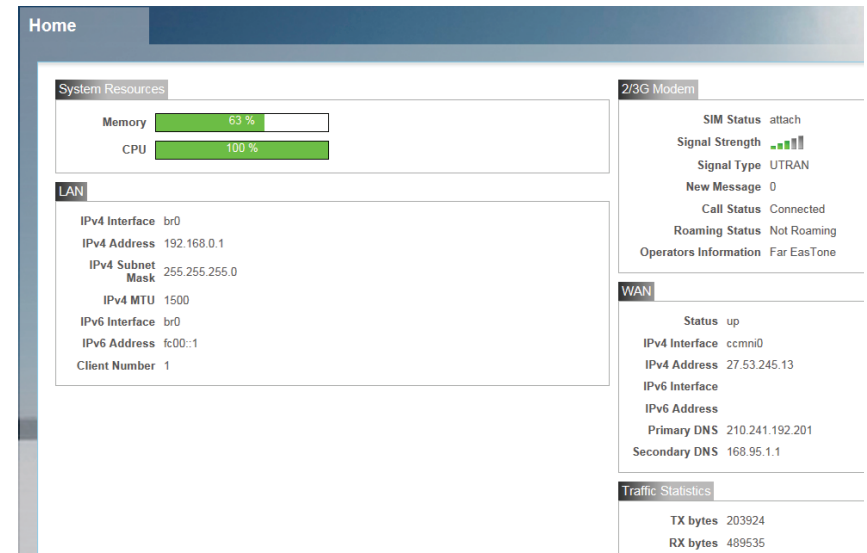

Wizard

The **Wizard** page will guide you through the steps required to configure the basic settings of your router such as the IP address, network name (SSID), and password. Click on the Wizard button on the navigation bar to commence the wizard.

LAN CONFIGURATION

IP Address: If you wish to change the router's IP address, enter the new address here. If you change the IP address from the default, you will need to enter the new address in your Internet browser's address bar in order to access the web-based configuration utility.

IP Subnet Mask: If you wish to change the router's subnet mask, enter it here.

Click **Next** to continue.

2/3G CONFIGURATION

If you wish to change the 2G or 3G service provider or connection type, click on a profile in the list to highlight it, and click **Set** to set that profile as the default.

Click **Next** to continue, or **Back** to return to the previous step.

Step 1
LAN Settings

Step 2
WAN Settings

Step 3
WiFi Settings

LAN Configuration

IP Address

IP Subnet Mask

Next

Step 1
LAN Settings

Step 2
WAN Settings

Step 3
WiFi Settings

Please consult with service provider for these settings. If not sure, leave them with default value.

2/3G Configuration

Type	Profile	
2/3G Data Connection	PID-7	<input type="button" value="Set"/>

Profile	Type	Name	APN	User	Password
PID-7	System	遠傳電信(Far EastOne)	internet		
PID-8	System	遠傳電信(Far EastOne)(Fetnet01)	fetnet01		

Total Num : 2

Back

Next

Wi-Fi CONFIGURATION

Password Setting: Choose a password for your wireless security. Clients will need this password in order to access your network wirelessly. If you are currently connected to the router using Wi-Fi, you will need to reconnect to the router using your new password once the wizard has been completed.

SSID: If you wish to change your wireless network name (SSID), enter a new name in the field provided. If you change the SSID, you may need to re-connect to the router using the new SSID before you can access your network or the configuration utility.

Click **Done** to complete the wizard, or click **Back** to return to the previous page.

After you have clicked **Done**, a confirmation window will appear. Click **OK** to save the configuration.

The screenshot shows a three-step wizard. Step 1 (LAN Settings) is in blue, Step 2 (WAN Settings) is in blue, and Step 3 (WiFi Settings) is highlighted in orange. Below the steps is a 'WiFi Configuration' section with a 'Password Setting' field and an 'SSID' field containing 'dlink_DWR-730'. At the bottom, there are 'Back' and 'Done' buttons.

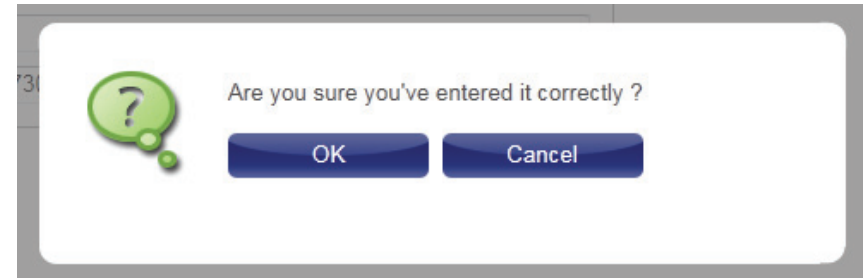

Internet Connection

This page allows you to configure the Internet settings for your mobile network connection. Use the tabs in the left-hand column to navigate through the different settings categories.

CONNECTION OPERATION

Flight Mode: Flight mode turns off all communications so that the device can be powered on safely when in an aircraft. Select whether you want to **Enable** or **Disable** flight mode from the drop-down menu, and click **Change** to effect the change.

Preferred Cellular Network: Select your preferred cellular network connection mode:

Auto Mode - The router will automatically connect to your preferred mobile network and remain connected while the device is powered on.

Manual Mode - You must manually connect to the preferred mobile network.

On Demand - The router will connect to the preferred mobile network when Internet access is required.

Click **Change** to effect the change.

Roaming Mode: Select whether you would like to **Enable** or **Disable** mobile network roaming from the drop-down menu.

Caution: Roaming on networks other than your own may incur additional usage charges.



Connection: Shows the type and status of the current mobile connection. To change the connection profile, select a user profile from the table below and click **Set** to activate the profile. Click **Disconnect** to manually disconnect the current mobile data service.

Profiles: The profiles table shows the details of currently configured user profiles. To add a new user profile, navigate to the **User Profile** tab at the top of this section.

Type	State	Signal	Profile			
2/3G Data Connection 1	Connected		PID-7	Set	Disconnect	

Profile	Type	Name	APN	Protocol	User	Password
PID-7	System	遠傳電信 (Far EasT one)	internet	IPv4		
PID-8	System	遠傳電信 (Far EasT one) (Fetnet01)	fetnet01	IPv4		

Total Num : 2

USER PROFILE

Click **Add** to add a new user profile.

Name: Enter a name to identify the new user profile.

APN: Enter the Access Point Name (APN) for the connection. If you do not know this information, please contact your service provider.

Protocol: Select the protocol to be used for the connection from the drop-down menu.

User: Enter the username to be used for this connection.

Password: Enter the password to be used for this connection.

Delete: Click the delete icon to delete this profile from the list.

Click **OK** to save the profile.

Click **Apply** to apply the profile settings and return to the Internet menu.

Connection | Connection Operation | **User Profile**

Profile	Name	APN	Protocol	User	Password	
	<input type="text"/>	<input type="text"/>	IPv4	<input type="text"/>	<input type="text"/>	

Total Num : 1

Add **OK**

Apply

2G/3G Modem

This section displays information about your 2G or 3G modem connection.

INFORMATION

Information: Displays information about your 2G or 3G modem.

SETTINGS

Network: Select your preferred modem type from the drop-down menu:

Auto - The modem will automatically select the modem type depending on the network it is connected to.

3G Only - The modem will only connect to 3G networks.

2G Only - The modem will only connect to 2G networks.

If you wish to change the modem type, select your new modem type and click **Change** to effect the change.
Re-enter the new PIN code.

Click **Apply** to apply the changes.



2/3G Modem Information Settings

Serial Number	30013051100035
IMEI	355189036250928
RSSI	-85 dBm

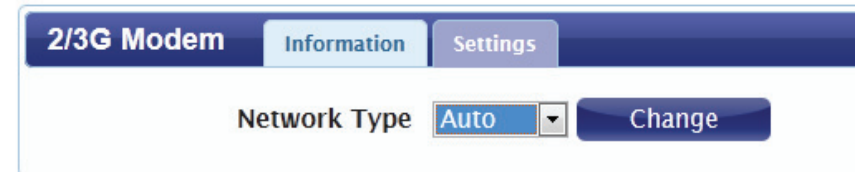

2/3G Modem Information Settings

Network Type

SIM

This section allows you to turn SIM lock on or off for the SIM card which is currently inserted into the router.

PIN Code: Enter the PIN code for the SIM card. Click **Enable** to turn on SIM lock, or click **Disable** to turn off SIM lock.

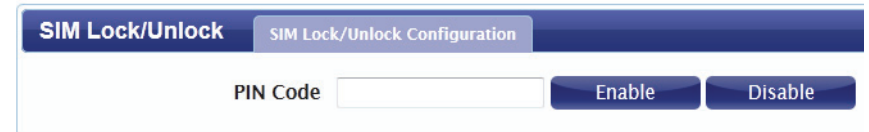

The screenshot shows a web interface for SIM Lock/Unlock configuration. It features a dark blue header with two tabs: "SIM Lock/Unlock" (selected) and "SIM Lock/Unlock Configuration". Below the header, there is a label "PIN Code" followed by a text input field. To the right of the input field are two buttons: "Enable" and "Disable".

PLMN

This page allows you to view available Public Land Mobile Networks (PLMN). This page can also be used to select a preferred network when you are roaming outside of your home network.

Mode: Select **Automatic** to allow the router to automatically connect to the first available network when roaming. Select **Manual** to choose your preferred roaming network from the list below.

If you have selected Manual mode, click on the preferred network to select it, and then click the **Update** button to select that network as the preferred network. Click **Query** to refresh the list of available networks.

Note: You will need to manually disconnect the current mobile data service before selecting a network using PLMN. Please refer to "Connection" on page 18 for further information on how to do this.

PLMN 2/3G Modem

Mode: Automatic

Status	PLMN number	Operator Name	Access Technology
Total Num : 0			

Update Query

Network

The **Network** pages allow you to check the current status of your Local Area Network (LAN), and make changes to LAN settings.

Wi-Fi

This section allows you to configure the IP settings for your wireless network.

IPv4

IP Address: Enter the IPv4 address for your Wi-Fi network. If you change this address, you will need to enter the new address in your web browser's address bar in order to access the web-based configuration utility.

IP Subnet Mask: Enter the IPv4 subnet mask for your Wi-Fi network.

Click **Apply** to save the current configuration.

IPv6

IPv6 Address: Enter the IPv6 address for your Wi-Fi network.

Prefix for LAN: Enter the prefix to be used to delegate IPv6 addresses to the LAN.

RA Autonomous: Check the box to set the router announcement mode to autonomous.

RA On-Link: Check the box to enable router announcement on-link

Click **Apply** to save the current configuration.

DNS NAME

DNS Device Name: Enter your router's DNS device name in the field provided.

Click **Apply** to save the current configuration.

WiFi IPv4 IPv6 DNS Name

IP Address 192.168.0.1
IP Subnet Mask 255.255.255.0

Apply

WiFi IPv4 IPv6 DNS Name

IPv6 Address fc00::1
Prefix for LAN fc00::/64
RA Autonomous
RA On-Link

Apply

WiFi IPv4 IPv6 DNS Name

DNS Device Name 192.168.0.1

Apply

DHCP

The DWR-730 has a built-in DHCP server which can assign IP addresses to connected clients. This section allows you to configure the DHCP settings.

DNS SERVER

First/Second/Third DNS Server: Select **None** from the drop-down menus if you do not wish to specify a first, second, or third DNS server. Select **User Define** to specify a DNS server, and enter the address of the server in the field provided.

Click **Apply** to save the current configuration.

STATIC DHCP

Use this option to specify a DHCP address reservation to a particular device or machine based on MAC address. To add a new reservation, click **Add**.

MAC Address: Enter the MAC address of the device or machine for which you wish to make the DHCP reservation.

IP Address: Enter the IP address that you wish to reserve. This address must be within the DHCP address pool.

Click **OK** to save the reservation.

LEASED HOSTS

This table shows the details of clients currently receiving a DHCP address from the DHCP server. Click **Refresh** to update the table.

DHCP Mode: Server

Start IP: 192.168.0.100

End IP: 192.168.0.199

Lease Time: 1440

Relay IP: 0.0.0.0

Metric Number: 30

Apply

#	MAC Address	IP Address
1	00:00:00:00:00:00	192.168.0.0

Total Num : 1

Add OK

Apply

#	Host Name	MAC Address	IP Address	Remaining Time
1	07869PCWIN7E	C8:D3:A3:03:43:86	192.168.0.100	23:49:05

Total Num : 1

Refresh

NAT

This section allows you to configure functions related to Network Address Translation (NAT) such as port triggering.

PORT TRIGGER

Use this option to have inbound traffic automatically forwarded to a dynamic address on the LAN when triggered by outbound traffic. To add a new port triggering rule, click **Add**.

Active: Check the box to activate this rule.

Name: Specify a name to identify the rule.

Trigger Protocol: Select **TCP** or **UDP** as the protocol for the trigger ports from the drop-down menu.

Trigger Port: Enter the starting and ending trigger port for the rule.

Open Protocol: Select **TCP** or **UDP** as the protocol for the ports to be opened from the drop-down menu.

Open Port(s): Enter the starting and ending ports to be opened when the trigger occurs.

Delete: Click the **Delete** icon to delete the rule.

Click **OK** to save the rule. Click **Apply** to apply the current rules and return to the Network page.

#	Active	Name	Trigger Protocol	Trigger Port(s)		Open Protocol	Open Port(s)		
				Start Port	End Port		Start Port	End Port	
1	<input checked="" type="checkbox"/>		TCP			TCP			

Total Num : 1

ALG

Application Level Gateways (ALG) allow certain applications to augment a network's firewall or NAT. This section enables you to enable various ALGs as required by specific applications. To enable an ALG, check the box next to the name of the rule.

SIP Port: Enter the Session Initiation Protocol (SIP) port required by your applications.

Click **Apply** to save the settings and return to the Network page.

The screenshot shows the NAT configuration interface with the following elements:

- NAT** (selected tab)
- Port Forward** (tab)
- Port Trigger** (tab)
- DMZ** (tab)
- ALG** (selected tab)
- Enable FTP ALG**
- Enable H.323 ALG**
- Enable IPsec ALG**
- Enable L2TP ALG**
- Enable PPTP ALG**
- Enable RTSP ALG**
- Enable SIP ALG**
- SIP Port**

SMS

The DWR-730 can send and receive SMS text messages through the mobile network's SMS function. In this section you can check the SIM card's inbox and outbox, as well as send new messages.

New Message

Send To: Enter the phone number that you wish to send the message to

Messages: Enter the body of the message to be sent.

Click **Apply** to save the current configuration.

Local

INBOX

This tab shows a summary of SMS messages in the inbox.

OUTBOX

This tab shows a summary of messages in the outbox which are yet to be sent.

Number	Message	Date/Time
Total Num : 0		

Wi-Fi

The **Wi-Fi** pages allow you to check the current status of your Wi-Fi network, and make changes to Wi-Fi settings.

Basic

This section allows you to configure your Wi-Fi network and specify the wireless security method to be used to secure your network.

Enable Check the box to enable the Wi-Fi function.

Mode: Select the desired 802.11 wireless mode from the drop-down menu. You should make your selection based on the standards supported by the wireless clients which will be connecting to your network.

Channel: To have the router automatically select the optimal wireless channel, select **Auto** from the drop-down menu. If you wish to select a particular channel, select it from the drop-down menu.

802.11N If you are using the 802.11n standard, you can manually select the channel width which best suits your network environment.

TxPower: Select the desired transmission power from the drop-down menu.

Beacon Interval: The beacon interval determines how often information about the wireless network is broadcast. It is recommended that you do not adjust this setting unless instructed to do so.

The screenshot shows the 'Basic' configuration page for Wi-Fi. The settings are as follows:

- Enable:**
- Mode:** 802.11 B/G/N mixed
- Channel:** channel 11
- 802.11N Channel Width:** HT20
- TxPower:** 10 dBm
- Beacon Interval (20 ~ 1024):** 100
- DTIM Period (1 ~ 255):** 1
- SSID:** dlink_DWR-730
- Hide SSID:**
- Encryption Type:** WPA Personal
- WPA Mode:** Auto(WPA or WPA2)
- Cipher Type:** AES
- Pre-shared Key:** 1234567890

An 'Apply' button is located at the bottom right of the configuration area.

DTIM Period: The Delivery Traffic Indication Message broadcasts information about buffered data to clients that are currently in low-power mode. Enter the desired DTIM period as a number of beacon intervals.

SSID: Enter the SSID (network name) to identify your wireless network.

Hide SSID: Check the box to hide the SSID of your network. If the SSID is hidden, wireless clients must manually enter it in order to connect to your network.

Encryption Type: Select the wireless encryption method that you wish to use from the drop-down menu. Depending on the method that you select, you may need to configure additional settings. For more information regarding wireless encryption and how to configure it, please refer to “Wireless Security” on page 31. If you do not wish to enable wireless security, select **None** from the drop-down menu.

Click **Apply** to save the current settings.

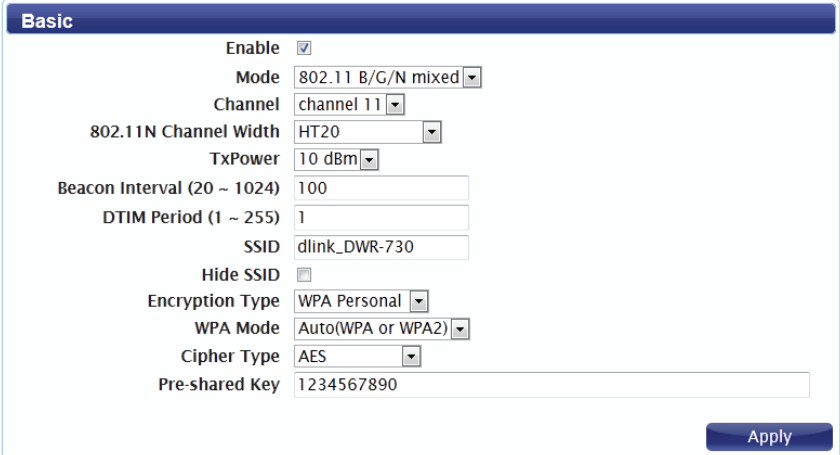

The screenshot shows a configuration window titled "Basic" with the following settings:

- Enable:
- Mode: 802.11 B/G/N mixed
- Channel: channel 11
- 802.11N Channel Width: HT20
- TxPower: 10 dBm
- Beacon Interval (20 ~ 1024): 100
- DTIM Period (1 ~ 255): 1
- SSID: dlink_DWR-730
- Hide SSID:
- Encryption Type: WPA Personal
- WPA Mode: Auto(WPA or WPA2)
- Cipher Type: AES
- Pre-shared Key: 1234567890

An "Apply" button is located at the bottom right of the configuration window.

Wireless Security

It is recommended that you enable wireless security on your router in order to protect your wireless network from unauthorized access. You should select a wireless security protocol that is compatible with the wireless clients which will be accessing your network.

Wired Equivalent Privacy (WEP)

Wired Equivalent Privacy (WEP) is an older wireless security standard, which although providing more protection than no security at all, has some weaknesses which could make it vulnerable to intrusion. It is recommended that you only use WEP if your wireless clients do not support Wi-Fi Protected Access (WPA). WEP is not supported by the 802.11n standard, and therefore you will not be able to achieve 802.11n speeds if using WEP.

Encryption Type: Select **WEP** from the drop-down menu.

Authentication Method: Select the desired authentication method from the drop-down menu:

Auto - The router will automatically determine the authentication method based on the client that is connecting to it.

Open System - Clients do not require authentication in order to associate with the router. The encryption key will be used to encrypt data packets sent over the network.

Shared - The encryption key is used for authentication as well as to encrypt data packets.

WEP Encryption Length: Select the length of the encryption key to be used.

Length: 64-bit - A 64-bit key comprises a string of 10 hexadecimal characters, or 5 ASCII characters.

128-bit - A 128-bit key comprises a string of 26 hexadecimal characters, or 13 ASCII characters.

Key 1-4: You can predetermine up to 4 WEP keys. Select the WEP key you wish to use by clicking on the radio buttons next to the keys. Select whether you wish to use **HEX** or **ASCII** characters in your key using the drop-down menu. Enter the desired key in the field provided. Click **Apply** to save the current settings.

Encryption Type	WEP	▼
Authentication Method	OPEN SYSTEM	▼
WEP Encryption Length	64-bit	▼
<input checked="" type="radio"/> Key 1	HEX	▼
<input type="radio"/> Key 2	HEX	▼
<input type="radio"/> Key 3	HEX	▼
<input type="radio"/> Key 4	HEX	▼

Wi-Fi Protected Access (WPA)

Wi-Fi Protected Access (WPA) is a newer and more secure encryption protocol which makes significant improvements over WEP. There are two versions of WPA; the original WPA, and the newer WPA2.

Encryption Type: Select **WPA Personal** from the drop-down menu.

WPA Mode: Select the desired authentication method from the drop-down menu:
Auto (WPA or WPA2) - The router will automatically determine the version of WPA to be used based on the client that is connecting to it.
WPA - Clients will only be able to associate with the router using the WPA standard.
WPA2 - Clients will only be able to associate with the router using the WPA2 standard. Clients which do not support WPA2 will not be able to associate with the router.

Cipher Type: Select the desired cipher type from the drop-down menu:
TKIP - This cipher is used by the WPA standard.
AES - A newer cipher used by the WPA2 standard. Use of this cipher type is required in order to achieve 802.11 speeds.

Pre-Shared Key The pre-shared key is the password which clients will require in order to connect to your network. Enter a password of between 8 and 63 characters in length.

Click **Apply** to save the current settings

Encryption Type	WPA Personal ▾
WPA Mode	Auto(WPA or WPA2) ▾
Cipher Type	TKIP and AES ▾
Pre-shared Key	1234567890

WLAN Authentication and Privacy Infrastructure (WAPI)

WLAN Authentication and Privacy Infrastructure (WAPI) is a wireless security standard which is implemented in China. You should only use this protocol if your wireless clients do not support any of the other security methods provided by the DWR-730.

Encryption Type: Select **WAPI Personal** from the drop-down menu.

WAPI Pre-Shared Select whether your key should use **ASCII** or **HEX** characters
Key: using the drop down menu. Enter your desired key in the field provided.

Click **Apply** to save the current settings.

Encryption Type	WAPI Personal ▼
WAPI Pre-Shared Key	ASCII ▼ 1234567890

Wi-Fi Protected Setup (WPS)

Wi-Fi Protected Setup (WPS) enables you to quickly and securely add compatible devices to your wireless network.

Enable: Check the box to enable the Wi-Fi Protected Setup feature.

Configure State: Select whether you wish to **Configure** or **Unconfigure** the WPS function using the radio buttons.

Configure Method: Select the WPS method that you wish to use. If your device supports Push Button Connection (PBC), simply select this option and click **Apply** to start the connection process. You will then have 120 seconds to press the WPS button on your wireless device in order to initiate the connection. If your device does not support PBC, you can select the PIN method and continue to the next step.

Current PIN: A PIN is a unique number that can be used to add the router to an existing network or to create a new network.

Generate PIN: For extra security, a new PIN can be generated. Click **Generate** to create a new PIN. The current PIN will be shown in the field next to **Current PIN**. This PIN can be used by wireless clients to join your network using the PIN method.

Enrollee PIN: If the device you are trying to add to the network was provided with a PIN number, select this option and enter the device's PIN in the field.

Click **Apply** to commence the connection process.

The screenshot shows the WPS configuration interface. At the top, there is a blue header with the text "WPS". Below the header, there are several configuration options:

- Enable:** A checkbox that is checked.
- Configure State:** Two radio buttons: "Unconfigure" (selected) and "Configure".
- Configure Method:** A dropdown menu with "PIN" selected.
- Current PIN:** A text input field containing "30332409" and a "Generate Pin" button.
- Enrollee PIN:** An empty text input field.
- Apply:** A blue button located at the bottom right of the form.

MAC Filter

The MAC filtering option allows you to allow or deny access to wireless clients based on their MAC address.

Enable MAC Address Filter: Check the box to enable the MAC filtering feature.

Mode: Select the filtering mode from the drop-down menu. You can choose to **Deny Listed Stations** access to your network, or **Allow Listed Stations** access.

LISTED STATIONS TABLE

To add a new filtering rule, click **Add**.

Active: Check the box to activate the rule.

Name: Enter a name to identify the machine or station which will be filtered.

MAC Address: Enter the MAC address of the machine or station which you wish to filter.

Delete: Click the **Delete** icon to delete the rule from the table.

Click **OK** to save the current rule and add it to the table.

Click **Apply** to save all changes and return to the Wi-Fi page.

MAC Filter

Enable MAC Address Filter

Mode: Deny listed stations

10 per page 1 page

#	Active	Name	MAC Address	
1	<input checked="" type="checkbox"/>		00:00:00:00:00:00	

Total Num : 1

Add OK

Apply

Station Lists

The Station List tab shows a list of all wireless clients currently connected to your wireless network.

Station Lists	
#	MAC Address
1	c8:d3:a3:03:43:86

Total Num : 1

Security

The Security tab allows you to configure your router's firewall settings and enable features to protect your network from outside intrusions and malicious attacks.

Firewall

IP Filter

Click **Add** to add a new filtering rule.

Active: Check the box to activate the IP filter rule.

Source IP: Enter the source IP address to be filtered.

Source From Port: Enter the starting port on the source IP.

Source To Port: Enter the ending port on the source IP.

Destination IP: Enter the destination IP address to be filtered.

Destination From Port: Enter the starting port of the destination IP.

Destination To Port: Enter the ending port of the destination IP.

Protocol: Select the protocol for the IP filter rule.

Delete: Click the icon to delete the IP filtering rule.

Click **OK** to save the filtering rule. Click **Apply** to save the current configuration.

#	Active	Source IP	Source From Port	Source To Port	Destination IP	Destination From Port	Destination To Port	Protocol	
1	<input checked="" type="checkbox"/>	0	0	0	0	0	0	TCP	

Total Num : 1

Buttons: Add, OK, Apply

IPv6 Filter

Click **Add** to add a new filtering rule.

Active: Check the box to activate the IP filter rule.

Source IP: Enter the source IP address to be filtered.

Source Port: Enter the port for the source IP.

Destination IP: Enter the destination IP address to be filtered.

Destination Port: Enter the port on the destination IP.

Protocol: Select the protocol for the IP filter rule.

Delete: Click the icon to delete the IP filtering rule.

Click **OK** to save the current filtering rule. Click **Apply** to save the current configuration.

The screenshot shows the 'Firewall' configuration page with the 'IPv6 Filter' tab selected. A table lists the active filtering rules. The first rule (ID 1) is checked as active. The fields for Source IP, Source Port (0), Destination IP, and Destination Port (0) are visible. The protocol is set to TCP. There are 'Add', 'OK', and 'Apply' buttons at the bottom right of the table area.

#	Active	Source IP	Source Port	Destination IP	Destination Port	Protocol	
1	<input checked="" type="checkbox"/>		0		0	TCP	

Total Num : 1

Buttons: Add, OK, Apply

MAC Filter

The MAC filter lets you to allow or deny access to your wireless network based on a client's MAC address.

Click **Add** to add a new MAC filtering rule.

Blacklist/Whitelist: Select **Blacklist** to deny access to only the MAC addresses listed below. Select **Whitelist** to allow access to only the MAC addresses listed below.

Active: Check the box to activate the MAC filter rule.

Source MAC: Enter the MAC address of the machine or device which you wish to filter packets coming from.

Destination MAC: Enter the MAC address of the machine you wish to filter packets.

Day: Check the box for each day that you wish to activate the MAC filtering rule.

Start Time: Enter the starting time at which you wish to activate the MAC filtering rule each day.

End Time: Enter the ending time at which you wish to deactivate the MAC filtering rule each day.

Delete: Click the icon to delete this MAC filtering rule.

Click **OK** to add the current rule to the rules list. Click **Apply** to save the current configuration.

The screenshot shows the 'MAC Filter' configuration page in a web interface. At the top, there are tabs for 'Firewall', 'IP Filter', 'IPv6 Filter', 'MAC Filter', 'DDOS', and 'Content Filter'. Below the tabs, there is a dropdown menu set to 'Blacklist/Whitelist' with 'Blacklist' selected. A table lists the filter rules. The first rule is active (checkbox checked) and has a 'Total Num' of 1. The table columns are: #, Active, Source MAC, Destination MAC, Mon, Tue, Wed, Thu, Fri, Sat, Sun, Start Time, and End Time. The Start Time is 00:00 and the End Time is 23:59. There are 'Add', 'OK', and 'Apply' buttons at the bottom right.

#	Active	Source MAC	Destination MAC	Mon	Tue	Wed	Thu	Fri	Sat	Sun	Start Time	End Time
1	<input checked="" type="checkbox"/>			<input checked="" type="checkbox"/>	<input checked="" type="checkbox"/>	<input checked="" type="checkbox"/>	<input checked="" type="checkbox"/>	<input checked="" type="checkbox"/>	<input checked="" type="checkbox"/>	<input checked="" type="checkbox"/>	00:00	23:59

Total Num : 1

Buttons: Add, OK, Apply

DDOS

This section allows you to enable various security features to protect against Denial of Service (DoS) attacks.

DoS Prevention Check the box next to the rule to enable prevention against
Filters: that specific kind of DoS attack.

Click **Apply** to save the current configuration.

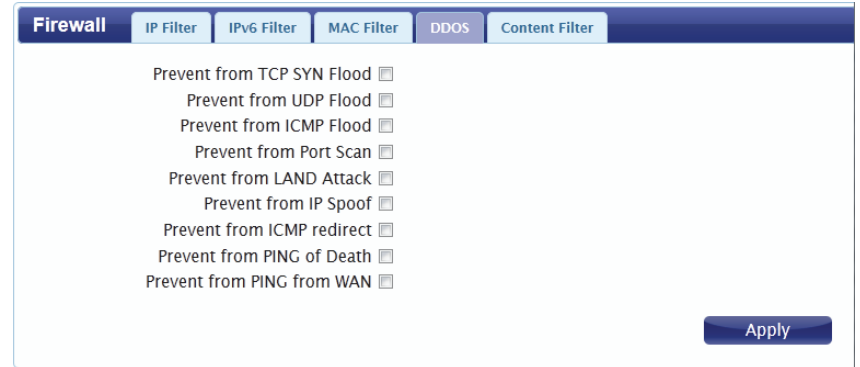

The screenshot shows a configuration window with a dark blue header containing the following tabs: Firewall, IP Filter, IPv6 Filter, MAC Filter, DDOS, and Content Filter. The 'DDOS' tab is currently selected. Below the tabs, there is a list of nine security features, each with a checkbox to its right:

- Prevent from TCP SYN Flood
- Prevent from UDP Flood
- Prevent from ICMP Flood
- Prevent from Port Scan
- Prevent from LAND Attack
- Prevent from IP Spoof
- Prevent from ICMP redirect
- Prevent from PING of Death
- Prevent from PING from WAN

In the bottom right corner of the window, there is a blue button labeled 'Apply'.

URL Filter

The content filter allows you to allow or deny access to specific URLs.

Enable URL Filter: Check the box to enable URL filtering.

Blacklist/Whitelist: Select **Blacklist** to deny access to only URLs listed in the rule

Whitelist: table. Select **Whitelist** to allow access to only URLs listed in the rule list.

Active: Check the box to activate the URL filtering rule.

URL: Enter the URL that you wish to allow or deny access to. If you enter a domain name, all URLs under this domain will be allowed or denied access.

Delete: Click the icon to delete the rule.

Click **Add** to save the rule and add it to the rule table. Click **Apply** to save the current configuration.

The screenshot shows the Firewall configuration interface with the Content Filter tab selected. The 'Enable URL Filter' checkbox is checked, and the 'Blacklist/Whitelist' dropdown is set to 'Blacklist'. A table below shows one rule with the following details:

#	Active	URL	
1	<input checked="" type="checkbox"/>		

Additional controls include a page size of 10 per page, a page number of 1, and buttons for 'Add', 'OK', and 'Apply'.

Application

This tab allows you to configure the router's administrative functions, such as time & date, remote access, and firmware. You can also access the system log.

About

This tab shows the router's basic information.

About	
Device Name	DWR-730 Configuration Manager
FW Version	V2.00_CN
IMEI	355189036250928

Configuration

BACKUP

Click **Backup** to save the router's current configuration to a file on your computer. You will then be prompted with a "save file" dialogue, where you can choose where to save the configuration file.

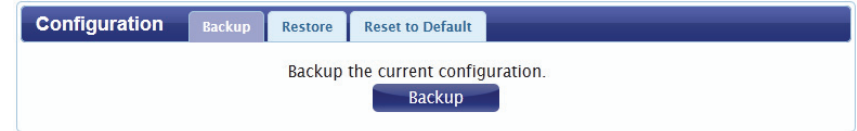

RESTORE

Click **Browse** to locate a previously saved configuration file on your computer. Once you have located the file, click **Restore** to configure the router according to the selected configuration file.

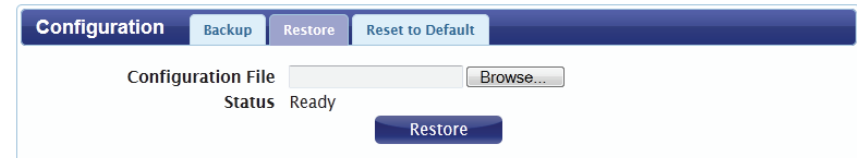

RESET TO DEFAULT

Click **Reset** to restore the router's settings to the factory defaults.

Important: All settings stored on the router will be lost following a factory reset.

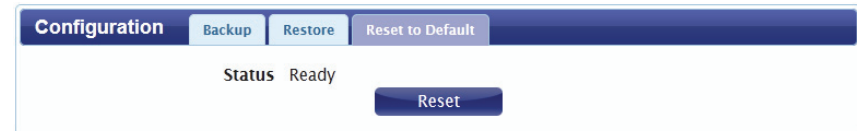

Firmware Upgrade

You can upgrade the firmware of the router here. Make sure the firmware file you want to use is on the local hard drive of the computer. Please check your local D-Link support site or <http://support.dlink.com> for firmware updates and language packs.

Click **Browse** to locate a previously downloaded firmware file on your computer. Once the file has been located, click **Update** to carry out the firmware upgrade process.

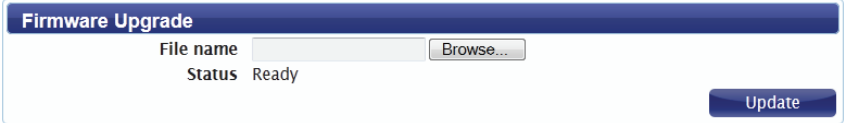

The screenshot shows a web interface titled "Firmware Upgrade". It contains a "File name" input field with a "Browse..." button to its right. Below the input field, the "Status" is displayed as "Ready". In the bottom right corner of the form, there is a blue "Update" button.

Important: All current settings will be restored to their factory defaults following a firmware upgrade.

Standby Mode

This section allows you to configure the router's automatic power-saving modes.

Enable Auto Power Saving: Check the box to enable the automatic power saving features.

Enter Standby Mode: Enter the number of minutes after which the router will enter standby mode if no activity is detected.

Enter Hibernate Mode: Enter the number of minutes after which the router will enter hibernate mode if no activity is detected.

Auto Power Off: Enter the number of minutes after which the router will shut down if no activity is detected.

Click **Apply** to save the current configuration.

The screenshot shows a configuration window titled "Standby Mode". It contains the following settings:

Enable Auto Power Saving	<input checked="" type="checkbox"/>
Enter Standby Mode (minutes)	<input type="text" value="5"/>
Enter Hibernate Mode (minutes)	<input type="text" value="5"/>
Auto Power Off (minutes)	<input type="text" value="120"/>

An "Apply" button is located in the bottom right corner of the window.

Password

This page lets you change the configuration interface passwords for the Administrator (Admin) and User accounts.

Select the user to change password: Select whether you wish to change the password for the admin or user account from the drop down menu.

Old Password: Enter the existing password for this account.

New Password: Enter the new password for this account.

Retype New Password: Type the new password again to confirm.

Click **Apply** to save the current configuration.

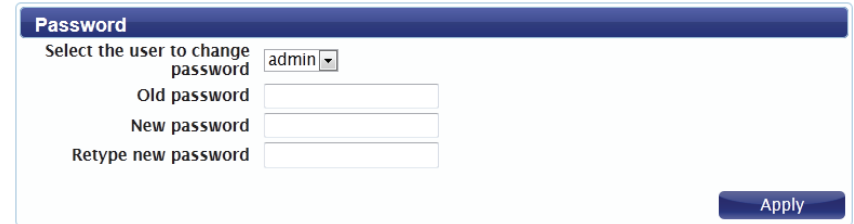

The screenshot shows a web form titled "Password" with a blue header. Below the header, there are four input fields and one button. The first field is a dropdown menu labeled "Select the user to change password" with "admin" selected. The second field is labeled "Old password". The third field is labeled "New password". The fourth field is labeled "Retype new password". A blue "Apply" button is located in the bottom right corner of the form.

Date and Time

This page lets you set the time and date for your router, and also configure automatic time synchronization and daylight savings time.

DATE

Current System Time: Displays the current time and date according to the router's system clock.

Mode: Select **Manual** to manually set the time and date, or select **Get from Time Server** to have the router automatically synchronize the time with a Network Time Protocol (NTP) server.

New Time: If you selected Manual mode, enter the current time.

New Date: If you selected Manual mode, enter the current date.

Time Protocol: If you selected Get time From Server, select the desired time protocol from the drop-down menu.

Time Server Address 1-4: Enter up to four NTP server addresses which will be used to synchronize the router's system time and date.

Click **Apply** to save the current settings.

The screenshot shows the 'Date and Time' configuration page. The 'Date' tab is active. The 'Current System Time' is 'Mon Jun 10 15:45:41 2013'. The 'Mode' is set to 'Manual'. The 'New Time (hh:mm:ss)' is '15 : 45 : 41'. The 'New Date (mm-dd-yyyy)' is '6 / 10 / 2013'. There is an 'Apply' button at the bottom right.

The screenshot shows the 'Date and Time' configuration page. The 'Date' tab is active. The 'Current System Time' is 'Mon Jun 10 15:45:41 2013'. The 'Mode' is set to 'Get from Time Server'. The 'Time Protocol' is 'NTP (RFC-1305)'. There are four 'Time Server Address' fields, all containing '1.my.pool.ntp.org', '2.my.pool.ntp.org', '3.my.pool.ntp.org', and '4.my.pool.ntp.org' respectively. There is an 'Apply' button at the bottom right.

TIME ZONE

Time Zone: Select your time zone from the drop-down menu.

Enable Daylight Saving: Check the box to enable automatic adjustment for daylight saving.

Start Date: Enter the details of the starting date and time for daylight saving time in your region.

End Date: Enter the details of the ending date and time for daylight saving time in your region.

Click **Apply** to save the current settings.

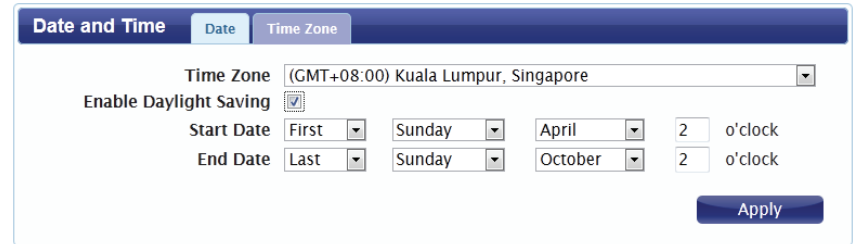

The screenshot shows the 'Date and Time' configuration page with the 'Time Zone' tab selected. The 'Time Zone' dropdown is set to '(GMT+08:00) Kuala Lumpur, Singapore'. The 'Enable Daylight Saving' checkbox is checked. The 'Start Date' is set to 'First' of 'Sunday' in 'April' at '2 o'clock'. The 'End Date' is set to 'Last' of 'Sunday' in 'October' at '2 o'clock'. An 'Apply' button is located at the bottom right of the configuration area.

Field	Value
Time Zone	(GMT+08:00) Kuala Lumpur, Singapore
Enable Daylight Saving	<input checked="" type="checkbox"/>
Start Date	First Sunday April 2 o'clock
End Date	Last Sunday October 2 o'clock

Language

Language: Select your preferred language from the drop-down menu.

Click **Apply** to save the current configuration.



The screenshot shows a configuration window titled "Language". Inside the window, there is a label "Language" followed by a dropdown menu currently displaying "English". To the right of the dropdown menu is a blue button labeled "Apply".

System Log

The system log displays a record of all events which occur while the router is running.

LOG SETTING

Enable Log: Check the box to enable the router's log-keeping function.

Click **Apply** to save the current configuration.

LOG DISPLAY

Refresh: Click to update the log display.

Clear Log: Click to clear all log entries.

Display Log Level: Select the level of log event which you wish to view from the drop-down menu.

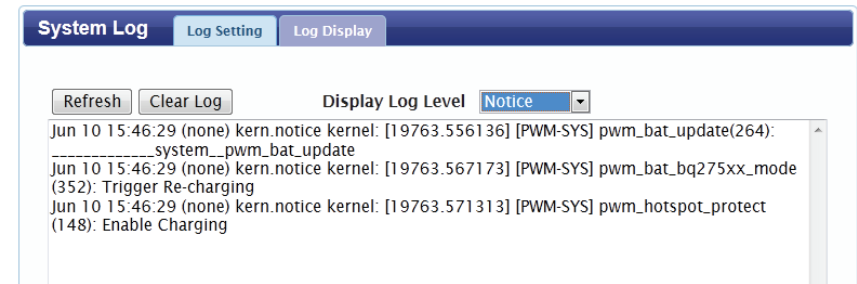
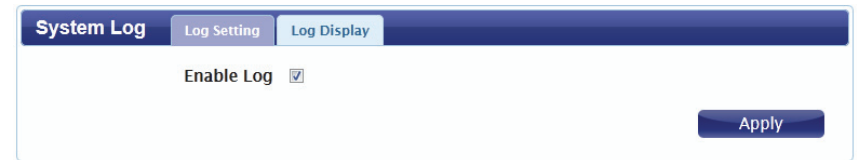

Connecting to a Wireless Network

Using Windows 8.1/8.0

It is recommended to enable wireless security (WPA/WPA2) on your wireless router or access point before configuring your wireless adapter. If you are joining an existing network, you will need to know the security key (Wi-Fi password) being used.

To join an existing network, locate the wireless network icon in the taskbar, next to the time display.



Clicking on this icon will display a list of wireless networks which are within connecting proximity of your computer. Select the desired network by clicking on the network name.

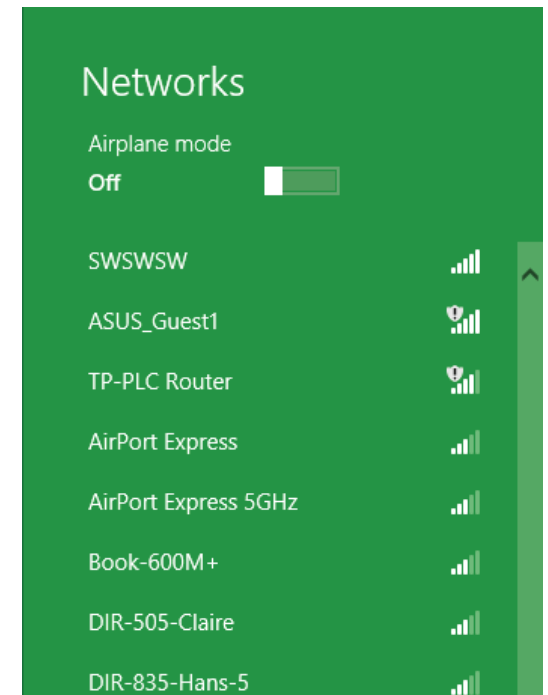

You will then be prompted to enter the network security key (Wi-Fi password) for the wireless network. Enter the password into the box and click Next.

If you wish to use Wi-Fi Protected Setup (WPS) to connect to the router, you can also press the WPS button on your router at this point to enable the WPS function.

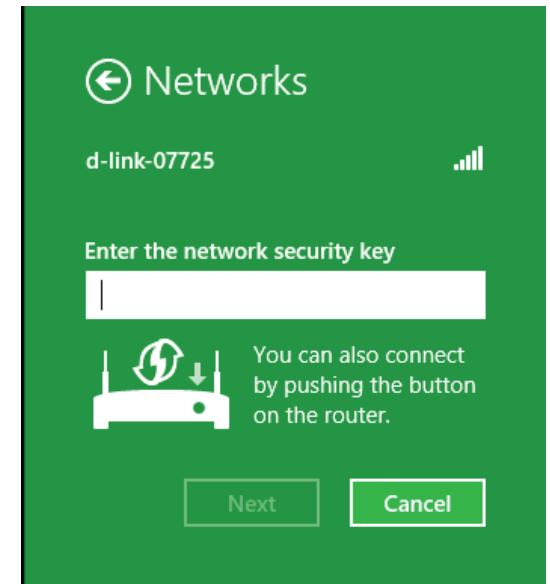

When you have established a successful connection to a wireless network, the word **Connected** will appear next to the name of the network to which you are connected.

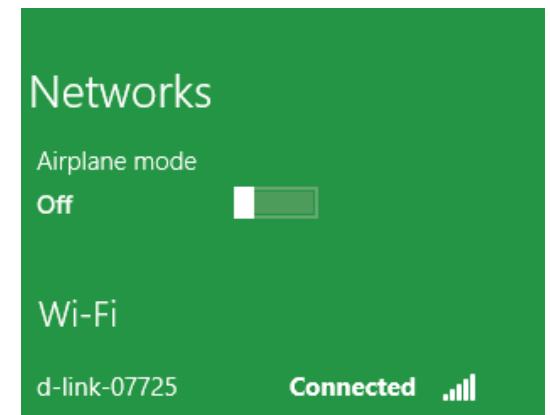

Using Windows 7

Windows 7 users may use the built-in wireless utility to connect to a wireless network. If you are using another company's utility or Windows 2000, please refer to the user manual of your wireless adapter for help with connecting to a wireless network. Most utilities will have a "site survey" option similar to the Windows 7 utility as seen below.

If you receive the Wireless Networks Detected bubble, click on the center of the bubble to access the utility. You can also click on the wireless icon in your system tray (lower-right corner).

The utility will display any available wireless networks in your area.

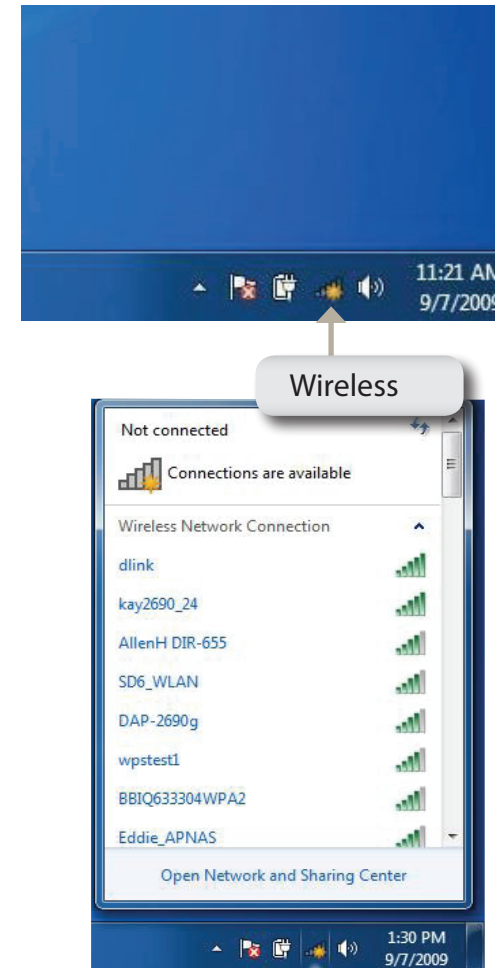

Highlight the wireless network (SSID) you would like to connect to and click the **Connect** button.

If you get a good signal but cannot access the Internet, check your TCP/IP settings for your wireless adapter. Refer to “Networking Basics” on page 70 for more information.



Configuring Wireless Security

It is recommended to enable wireless security (WPA/WPA2) on your wireless router or access point before configuring your wireless adapter. If you are joining an existing network, you will need to know the security key or passphrase being used.

1. Click on the wireless icon in your system tray (lower-right corner).

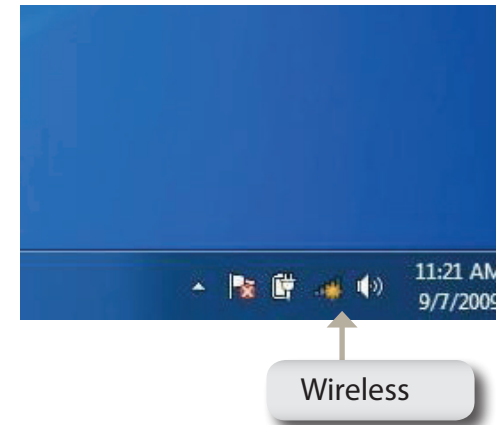

2. The utility will display any available wireless networks in your area.

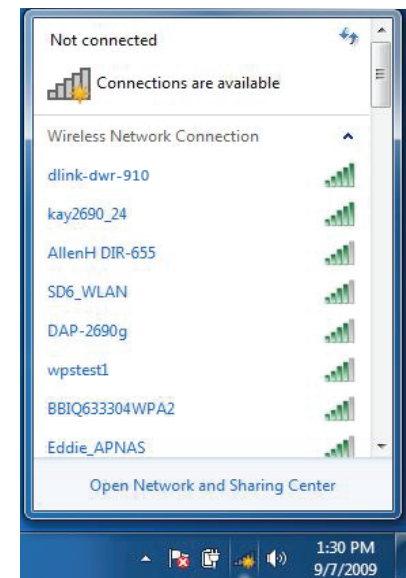

3. Highlight the wireless network (SSID) you would like to connect to and click the **Connect** button.



4. The following window appears while your computer tries to connect to the router.

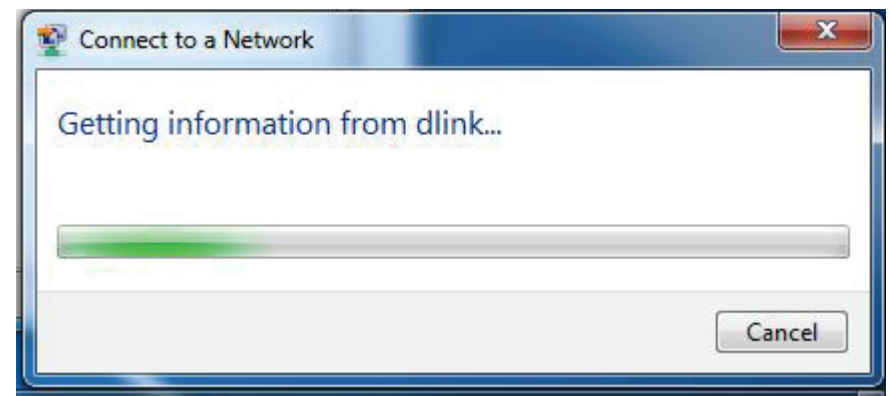

5. Enter the same security key or passphrase that is on your router and click **Connect**.

It may take 20-30 seconds to connect to the wireless network. If the connection fails, please verify that the security settings are correct. The key or passphrase must be exactly the same as on the wireless router.



Using Windows Vista™

Windows® Vista™ users may use the built-in wireless utility. If you are using another company's utility or Windows® 2000, please refer to the user manual of your wireless adapter for help with connecting to a wireless network. Most utilities will have a "site survey" option similar to the Windows® Vista™ utility as seen below.

If you receive the **Wireless Networks Detected** bubble, click on the center of the bubble to access the utility.

or

Right-click on the wireless computer icon in your system tray (lower-right corner next to the time). Select **Connect to a network**.

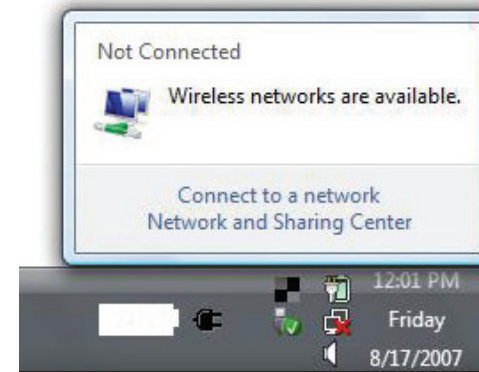

The utility will display any available wireless networks in your area. Click on a network (displayed using the SSID) and click the **Connect** button.

If you get a good signal but cannot access the Internet, check the TCP/IP settings for your wireless adapter. Refer to "Networking Basics" on page 70 for more information.

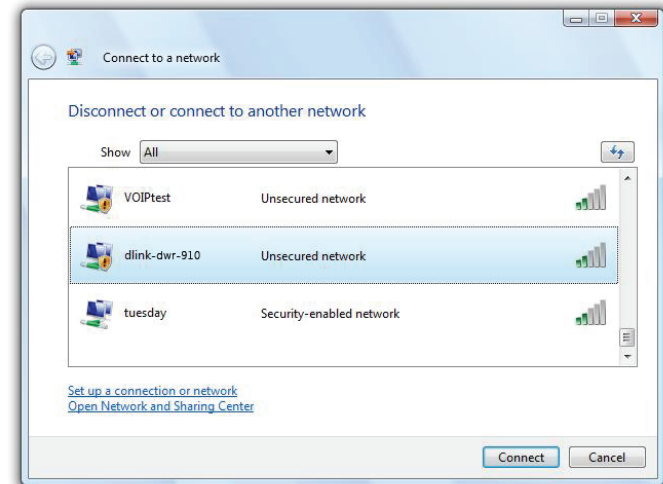

Configuring Wireless Security

It is recommended to enable wireless security (WEP/WPA/WPA2) on your wireless router or access point before configuring your wireless adapter. If you are joining an existing network, you will need to know the security key or passphrase being used.

1. Open the Windows® Vista™ Wireless Utility by right-clicking on the wireless computer icon in your system tray (lower right corner of screen). Select **Connect to a network**.

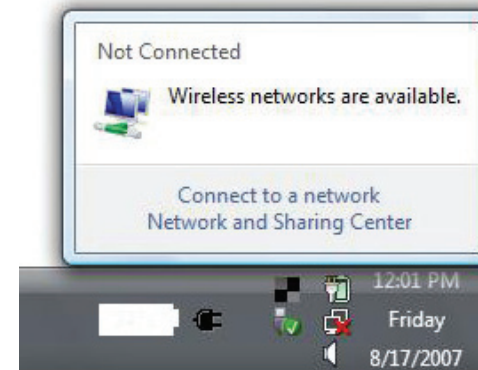

2. Highlight the wireless network (SSID) you would like to connect to and click **Connect**.

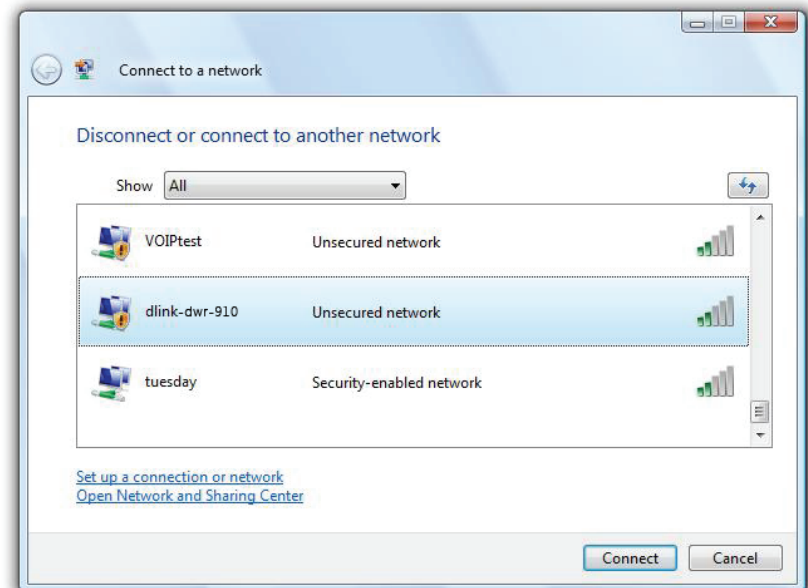

3. Enter the same security key or passphrase that is on your router and click **Connect**.

It may take 20-30 seconds to connect to the wireless network. If the connection fails, please verify that the security settings are correct. The key or passphrase must be exactly the same as on the wireless router.

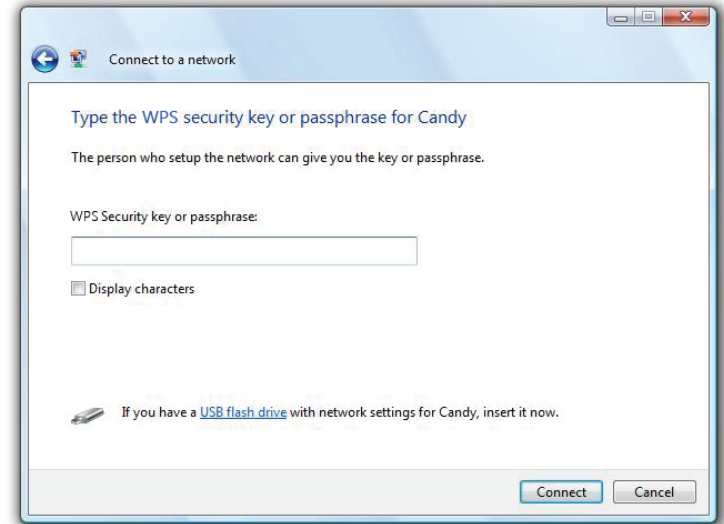

Connect to a Wireless Network Using Windows® XP

Windows® XP users may use the built-in wireless utility (Zero Configuration Utility). The following instructions are for Service Pack 2 users. If you are using another company's utility or Windows® 2000, please refer to the user manual of your wireless adapter for help with connecting to a wireless network. Most utilities will have a "site survey" option similar to the Windows® XP utility as seen below.

If you receive the **Wireless Networks Detected** bubble, click on the center of the bubble to access the utility.

or

Right-click on the wireless computer icon in your system tray (lower-right corner next to the time). Select **View Available Wireless Networks**.

The utility will display any available wireless networks in your area. Click on a network (displayed using the SSID) and click the **Connect** button.

If you get a good signal but cannot access the Internet, check the TCP/IP settings for your wireless adapter. Refer to "Networking Basics" on page 70 for more information.

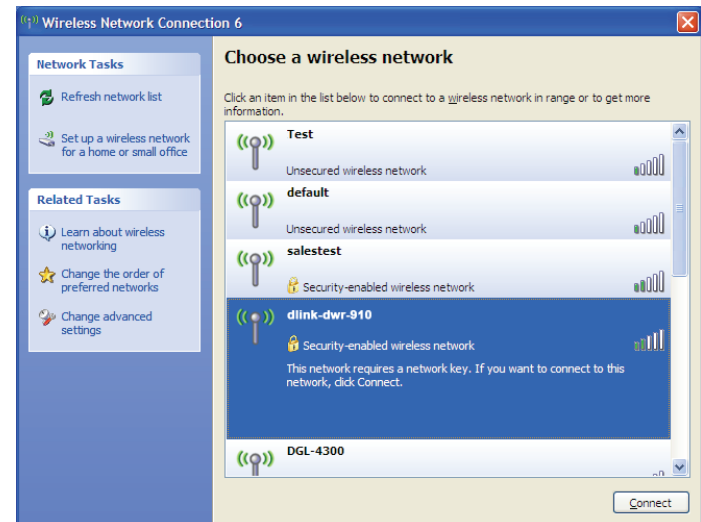
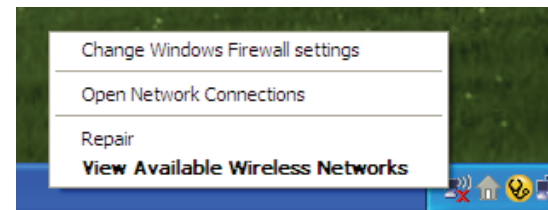
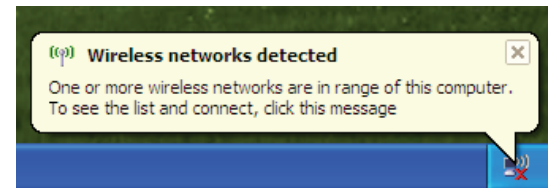

Configure WEP

It is recommended to enable WEP on your wireless router or access point before configuring your wireless adapter. If you are joining an existing network, you will need to know the WEP key being used.

1. Open the Windows® XP Wireless Utility by right-clicking on the wireless computer icon in your system tray (lower-right corner of screen). Select **View Available Wireless Networks**.

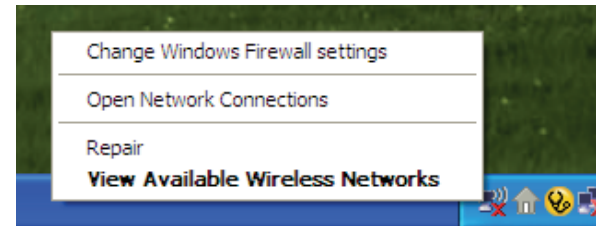

2. Highlight the wireless network (SSID) you would like to connect to and click **Connect**.

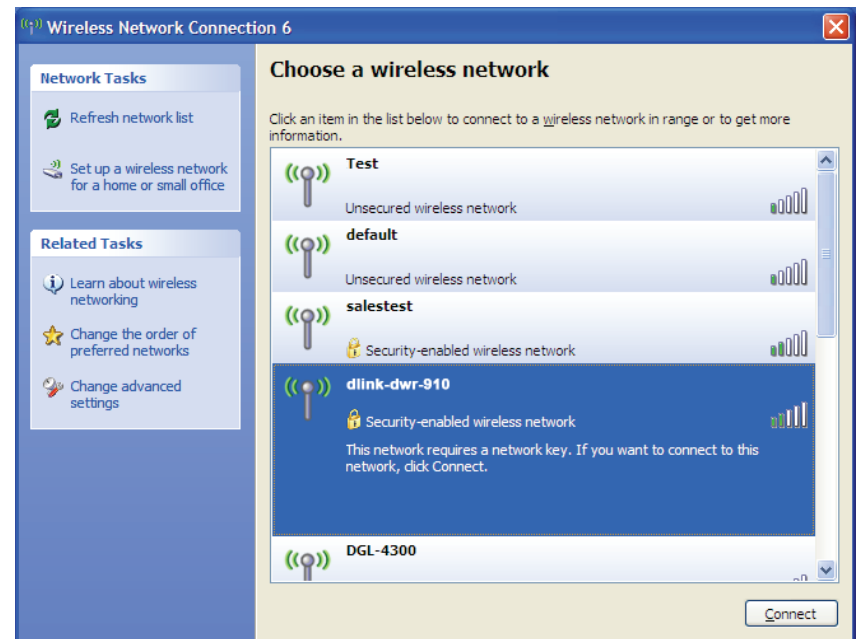

3. The **Wireless Network Connection** box will appear. Enter the same WEP key that is on your router and click **Connect**.

It may take 20-30 seconds to connect to the wireless network. If the connection fails, please verify that the WEP settings are correct. The WEP key must be exactly the same as on the wireless router.

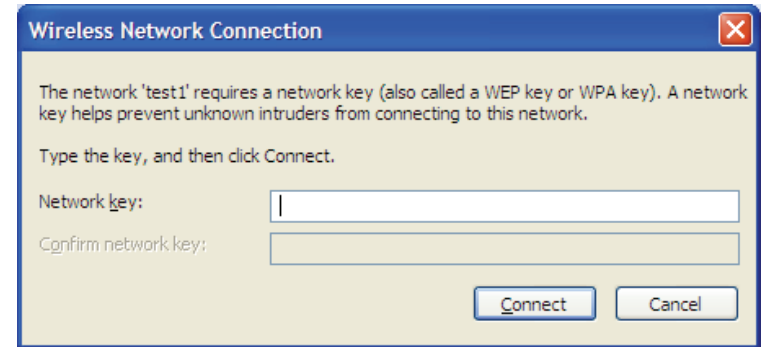

Configure WPA-PSK

It is recommended to enable WPA on your wireless router or access point before configuring your wireless adapter. If you are joining an existing network, you will need to know the WPA key being used.

1. Open the Windows® XP Wireless Utility by right-clicking on the wireless computer icon in your system tray (lower-right corner of screen). Select **View Available Wireless Networks**.

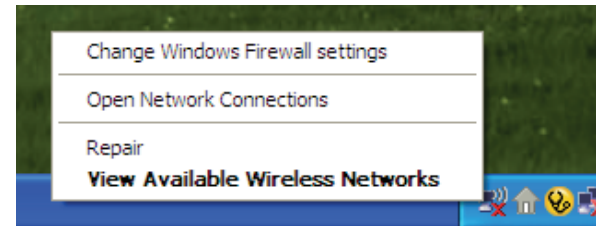

2. Highlight the wireless network (SSID) you would like to connect to and click **Connect**.

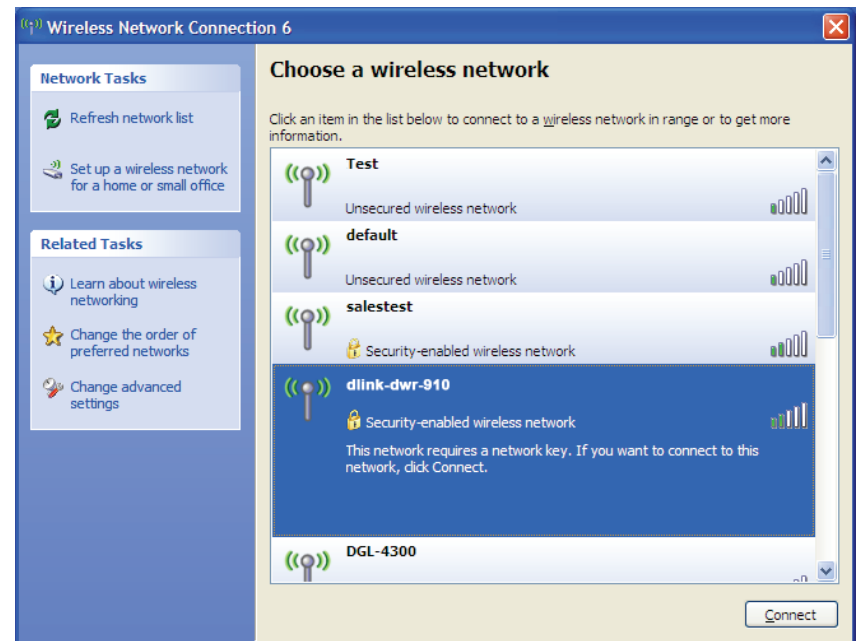

3. The **Wireless Network Connection** box will appear. Enter the WPA-PSK passphrase and click **Connect**.

It may take 20-30 seconds to connect to the wireless network. If the connection fails, please verify that the WPA-PSK settings are correct. The WPA-PSK passphrase must be exactly the same as on the wireless router.

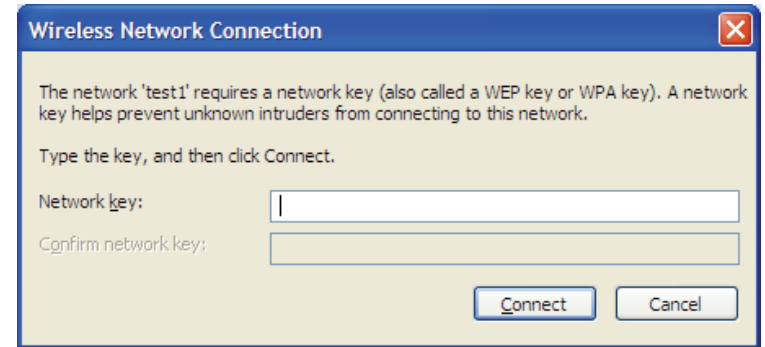

Using Mac OS

It is recommended to enable wireless security (WPA/WPA2) on your wireless router or access point before configuring your wireless adapter. If you are joining an existing network, you will need to know the security key (Wi-Fi password) being used.

To quickly access your Wi-Fi information and settings, click the Wi-Fi icon on the menu bar.

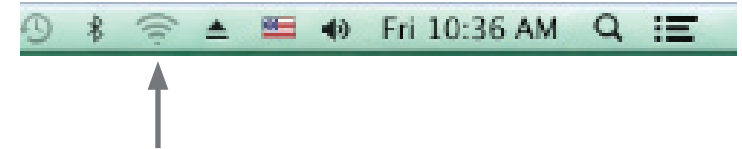

Clicking on this icon will display a list of all wireless networks within range of your computer. Select the desired network by clicking on the network name.



You will then be prompted to enter the network security key (Wi-Fi password) for the wireless network. Enter the password into the box and click **Join**.

Note: To avoid having to enter your network security key each time you connect, check **Remember this network**.



Once the connection is successfully established, you will see a check by the name of your wireless network.

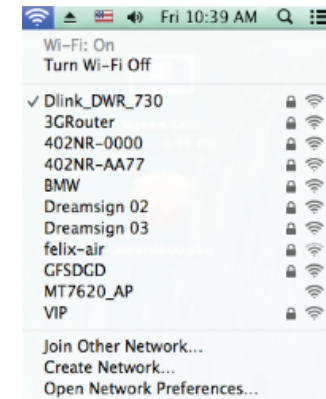

Troubleshooting

This chapter provides solutions to problems that can occur during the installation and operation of the DWR-730. Read the following descriptions if you are having problems.

1. Why can't I access the web-based configuration utility?

When entering the IP address of your router (192.168.0.1 for example), you are not connecting to a website on the Internet or have to be connected to the Internet. The device has the utility built-in to a ROM chip in the device itself. Your computer must be on the same IP subnet to connect to the web-based utility.

- Make sure you have an updated Java-enabled web browser. We recommend the following:
 - Internet Explorer 8 or higher, Chrome 19.0, Firefox 12.0, or Safari 4.0.
- If attempting to connect wirelessly, ensure that the wireless icon on the OLED display is showing. Also, ensure that you are connected to the correct SSID for your mobile router.
- Make sure that the computer you are using is not connected to any other devices (such as routers or switches) which might have the same IP address as the DWR-730, as this may cause an IP address conflict. If you have a conflict, temporarily unplug any other devices from your computer while you configure the DWR-730. You can also change the IP address of the DWR-730 in the Network section of the configuration utility. Please refer to "Wi-Fi" on page 24 for further information on changing the IP address. You may also need to renew your computer's IP address configuration. To do this, start the Command utility: Click on **Start > Run**. In the run box type **cmd** and click **OK**. (Windows Vista users type **cmd** in the **Start Search** box.) This will bring up a black screen with white text. At the command prompt, type **ipconfig /release** and wait for the process to be completed. Next, type **ipconfig /renew** which will renew your computer's IP address configuration.
- Disable any Internet security software running on the computer. Software firewalls such as ZoneAlarm, BlackICE, Sygate, Norton Personal Firewall, and Windows® XP firewall may block access to the configuration pages. Check the help files included with your firewall software for more information on disabling or configuring it.

- Configure your Internet settings:
 - Go to **Start > Settings > Control Panel**. Double-click the **Internet Options** Icon. From the **Security** tab, click the **Default Level** button to restore the settings to their defaults.
 - Click the **Connection** tab and set the dial-up option to Never Dial a Connection. Click the LAN Settings button. Make sure nothing is checked. Click **OK**.
 - Go to the **Advanced** tab and click the button to restore these settings to their defaults. Click **OK** three times.
 - Close your web browser (if open) and re-open it.

2. What can I do if I forgot my password?

If you forgot your password, you must reset your router. Please note that this process will change all your settings back to the factory defaults.

To reset the router, first remove the back cover of the router to expose the battery. Using a paperclip or similar object, press and hold the reset button, which is located inside the hole to the upper-left of the SIM card slot (see diagram). The DWR-730 will restore the factory default settings. Wait about 30 seconds for the router to restart before you attempt to reconnect to it. The default IP address is 192.168.0.1, and the default username is **admin** and the password should be left blank.

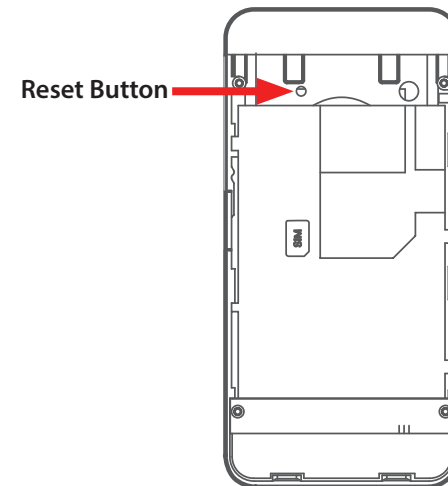

Networking Basics

Check your IP address

After you install your new D-Link adapter, by default, the TCP/IP settings should be set to obtain an IP address from a DHCP server (i.e. wireless router) automatically. To verify your IP address, please follow the steps below.

Click on **Start > Run**. In the run box type *cmd* and click **OK**. (Windows® Vista™ users type *cmd* in the **Start Search** box.)

At the prompt, type *ipconfig* and press **Enter**.

This will display the IP address, subnet mask, and the default gateway of your adapter.

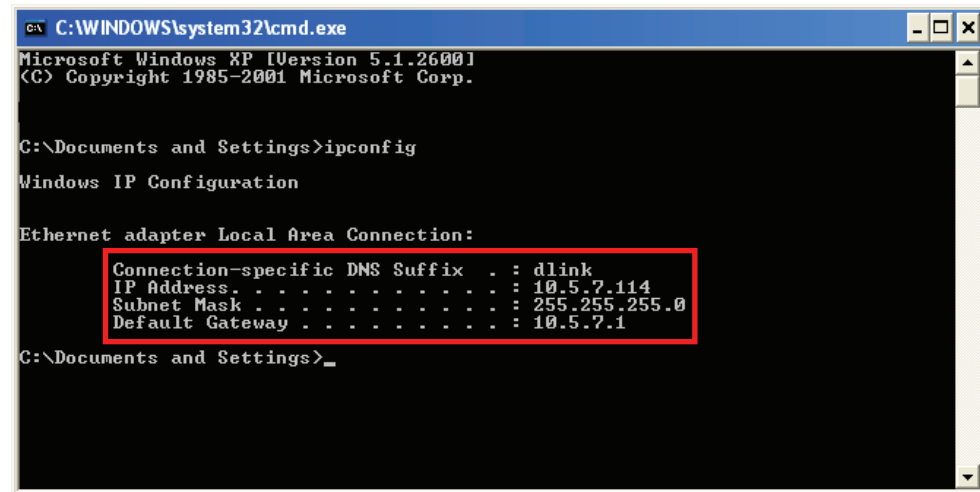

```
C:\WINDOWS\system32\cmd.exe
Microsoft Windows XP [Version 5.1.2600]
(C) Copyright 1985-2001 Microsoft Corp.

C:\Documents and Settings>ipconfig

Windows IP Configuration

Ethernet adapter Local Area Connection:

    Connection-specific DNS Suffix . : dlink
    IP Address. . . . . : 10.5.7.114
    Subnet Mask . . . . . : 255.255.255.0
    Default Gateway . . . . . : 10.5.7.1

C:\Documents and Settings>_
```

If the address is 0.0.0.0, check your adapter installation, security settings, and the settings on your router. Some firewall software programs may block a DHCP request on newly installed adapters.

Statically Assign an IP address

If you are not using a DHCP capable gateway/router, or you need to assign a static IP address, please follow the steps below:

Step 1

- Windows® 8 Click on **Start > Control Panel > Network and Internet Connections > Network Connections > Configure your Internet Protocol (IP) settings.**
- Windows® 7 Click on **Start > Control Panel > Network and Internet > Network and Sharing Center > Manage Network Connections.**
- Windows® Vista™ Click on **Start > Control Panel > Network and Internet > Network and Sharing Center > Manage Network Connections.**
- Windows® XP Click on **Start > Control Panel > Network Connections.**

Step 2

Right-click on the **Local Area Connection** which represents your network adapter and select **Properties.**

Step 3

Highlight **Internet Protocol (TCP/IP)** and click **Properties.**

Step 4

Click **Use the following IP address** and enter an IP address that is on the same subnet as your network or the LAN IP address on your router.

Example: If the router's LAN IP address is 192.168.0.1, make your IP address 192.168.0.X where X is a number between 2 and 99. Make sure that the number you choose is not in use on the network. Set Default Gateway the same as the LAN IP address of your router (192.168.0.1).

Set Primary DNS the same as the LAN IP address of your router (192.168.0.1). The Secondary DNS is not needed or you may enter a DNS server from your ISP.

Step 5

Click **OK** twice to save your settings.

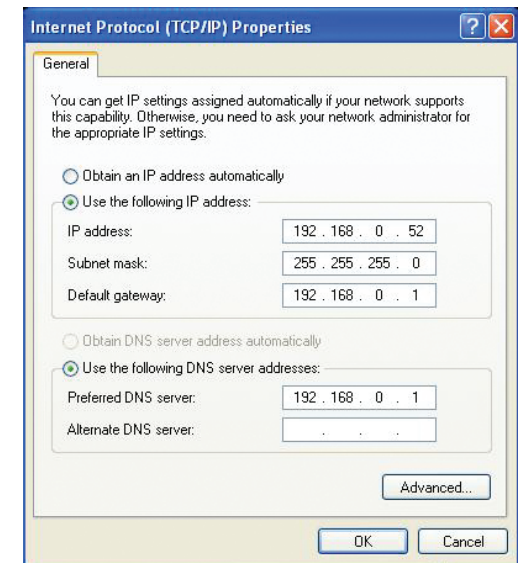

Technical Specifications

Radio Frequency Bands

- HSPA/HSPDA/UMTS: 900/2100 MHz
- EDGE/GPRS/GSM: 850/900/1800/2100 MHz
- Power Class 3 (+23 dBm)

Cellular Access

- HSPA+
 - Downlink: 21 Mbps
 - Uplink: 5.76 Mbps

Wi-Fi Access Point

- 802.11n (150 Mbps compatible)
- 802.11g (54 Mbps)
- 802.11b (11 Mbps)

Antenna

- One internal antenna

USB Interface

- micro USB port

USIM Slot

- Standard 6-pin SIM card interface

Status Indicators

- OLED display

Storage

- microSD card slot

Wireless Security

- 64/128-bit WEP (Wired Equivalent Privacy)
- WPA & WPA2 (Wi-Fi Protected Access)
- WAPI (WLAN Authentication and Privacy Infrastructure)

Firewall

- Network Address Translation (NAT)

Dimensions (L x W x H)

- 100.3 x 49.35 x 14.13 mm (3.95 x 1.94 x 0.56 inches)

Weight

- 90 g (3.17 ounces)

Operating Temperature

- -10 to 55 °C (14 to 131 °F)

Certifications

- FCC/CE

Warnings and Declarations

Specific Absorption Rate (SAR)

This mobile device is a radio transmitter and receiver. It is not designed to exceed the limits for exposure to radio waves recommended by international guidelines. These guidelines were developed by the independent scientific organization ICNIRP and include safety margins designed to assure the protection of all persons, regardless of age and health.

The guidelines use a unit of measurement known as the Specific Absorption Rate, or SAR.

The SAR limit for mobile devices is 2 W/kg and the highest SAR value for this device when tested complied with this limit.

To comply with radiofrequency radiation (RF) exposure guidelines during body worn operation, this device must be used with a minimum of 1.5 cm separation from the body.

Failure to observe these instructions could result in your RF exposure exceeding the relevant guideline limits.