



MORE INFORMATION



MANUAL



All materials are compatible with RoHS requirements.



P12 Pro A-RGB

120 mm A-RGB PWM Fan with Cable Splitter

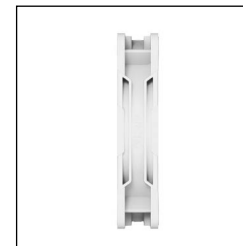
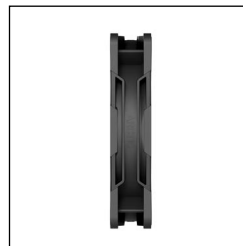

Specifications P12 Pro A-RGB

General Specifications

Warranty	6 Years
Operating Ambient Temperature	0–40 °C
Dimensions	120 (L) x 120 (W) x 25 (H) mm
Net Weight	185 g

Fan Specifications

Fan Speed	600–3000 rpm (PWM controlled), 0 rpm below 5% PWM
Airflow	77 cfm 131 m³/h
Static Pressure	6.9 mmH ₂ O
Fan Bearing	Fluid Dynamic Bearing
Typical Voltage	12 V DC
Start Up Voltage	3.3 V DC
Current	0.33 A
Cable Length	400 mm + 80 mm Daisy-Chain Cable
Connector	4-Pin Fan Plug + 4-Pin Socket

RGB-Spezifikationen

LEDs	12x A-RGB LEDs
Current Voltage	0.40A 5VDC
Connector	3-Pin A-RGB Plug + 3-Pin Socket

4-Pin Fan Plug + 4-Pin Socket

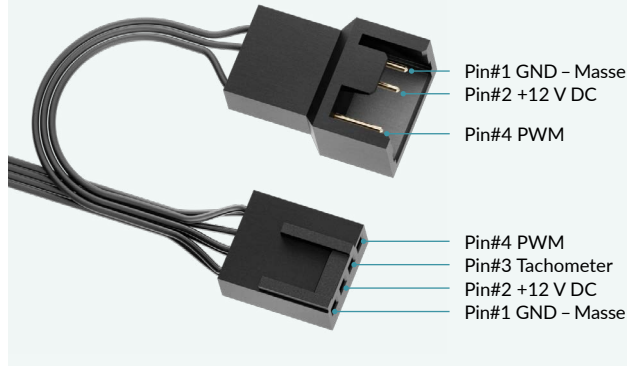

3-Pin A-RGB Plug + 3-Pin Socket

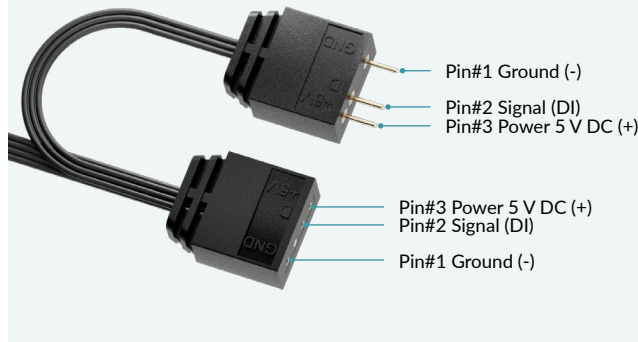

P/Q Curve

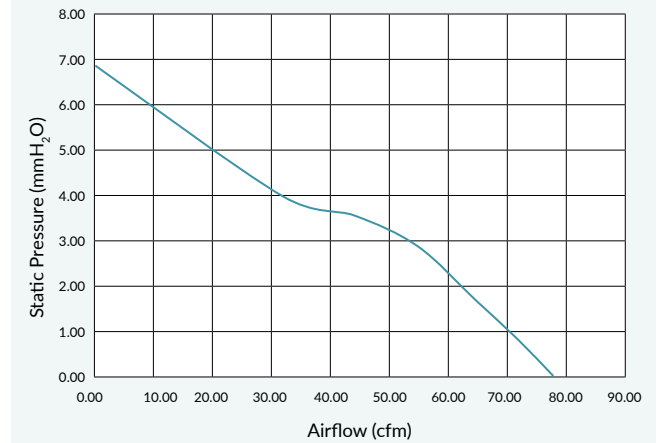

PWM Control Curve

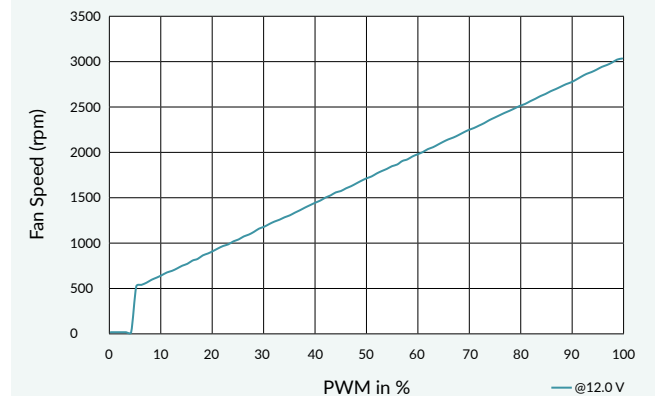

Dimensions

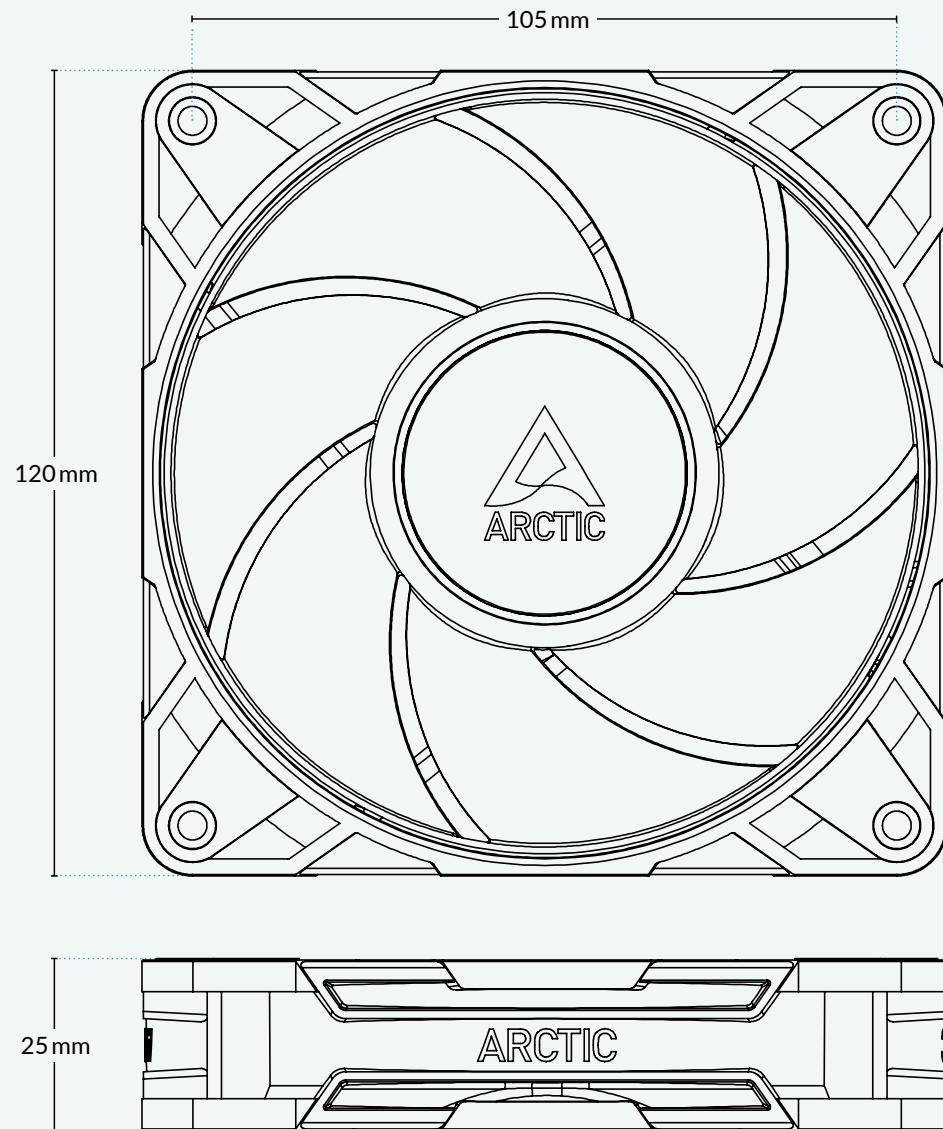

Shipping Information P12 Pro A-RGB

Box Dimension	127 (L) x 125 (W) x 30 (H) mm
Gross Weight	221 g
SKU	ACFAN00309A
EAN	4895265000119
UPC	840033402798
Box Content	P12 Pro A-RGB x1 Mounting Screws x4

Shipping Information P12 Pro A-RGB (White)

Box Dimension	127 (L) x 125 (W) x 30 (H) mm
Gross Weight	221 g
SKU	ACFAN00311A
EAN	4895265000133
UPC	840033402811
Box Content	P12 Pro A-RGB (White) x1 Mounting Screws x4

Shipping Information P12 Pro A-RGB - 3 Pack

Box Dimension	127 (L) x 124 (W) x 86 (H) mm
Gross Weight	633 g
SKU	ACFAN00310A
EAN	4895265000126
UPC	840033402804
Box Content	P12 Pro A-RGB x3 Mounting Screws x12

Shipping Information P12 Pro A-RGB (White) - 3 Pack

Box Dimension	127 (L) x 124 (W) x 86 (H) mm
Gross Weight	633 g
SKU	ACFAN00326A
EAN	4895265000683
UPC	840033403351
Box Content	P12 Pro A-RGB (White) x3 Mounting Screws x12