

# TravelMate 8371/4371 Series

## Quick Guide

Copyright © 2009. Acer Incorporated.  
All Rights Reserved.

TravelMate 8371/4371 Series Quick Guide  
Original Issue: 05/2009

Changes may be made periodically to the information in this publication without obligation to notify any person of such revisions or changes. Such changes will be incorporated in new editions of this manual or supplementary documents and publications.

Record the model number, serial number, purchase date and place of purchase information in the space provided below. The serial number and model number are recorded on the label affixed to your computer. All correspondence concerning your unit should include the serial number, model number and purchase information.

This booklet has been reviewed for accuracy. Although Acer makes all reasonable attempts for this booklet to be printed in an accurate manner, Acer takes no responsibility for any inadvertent errors or misprints. Acer's liability with respect to this booklet is subject to any limitation of liability set out in the applicable product warranty.

No part of this publication may be reproduced, stored in a retrieval system, or transmitted, in any form or by any means, electronically, mechanically, by photocopy, recording or otherwise, without the prior written permission of Acer Incorporated.

TravelMate 8371/4371 Series Notebook PC

Model number: \_\_\_\_\_

Serial number: \_\_\_\_\_

Date of purchase: \_\_\_\_\_

Place of purchase: \_\_\_\_\_

Acer and the Acer logo are registered trademarks of Acer Incorporated. Other companies' product names or trademarks are used herein for identification purposes only and belong to their respective companies.

# First things first

We would like to thank you for making an Acer notebook your choice for meeting your mobile computing needs.

## Your guides

To help you use your Acer notebook, we have designed a set of guides:

First off, the **Just for Starters...** poster helps you get started with setting up your computer.

The **TravelMate Series Generic User Guide** contains useful information applying to all models in the TravelMate product series. It covers basic topics such as using the keyboard and audio, etc. Please understand that due to its nature, the **Generic User Guide** as well as the **AcerSystem User Guide** mentioned below will occasionally refer to functions or features which are only contained in certain models of the series, but not necessarily in the model you purchased. Such instances are marked in the text with language such as "only for certain models".

The **Quick Guide** introduces you to the basic features and functions of your new computer. For more on how your computer can help you to be more productive, please refer to the **AcerSystem User Guide**. This guide contains detailed information on such subjects as system utilities, data recovery, expansion options and troubleshooting. In addition it contains warranty information and the general regulations and safety notices for your notebook. It is available in Portable Document Format (PDF) and comes preloaded on your notebook. Follow these steps to access it:

- 1 Click on  **Start, All Programs, AcerSystem.**
- 2 Click on **AcerSystem User Guide.**



.....

**Note:** Viewing the file requires Adobe Reader. If Adobe Reader is not installed on your computer, clicking on **AcerSystem User Guide** will run the Adobe Reader setup program first. Follow the instructions on the screen to complete the installation. For instructions on how to use Adobe Reader, access the **Help and Support** menu.







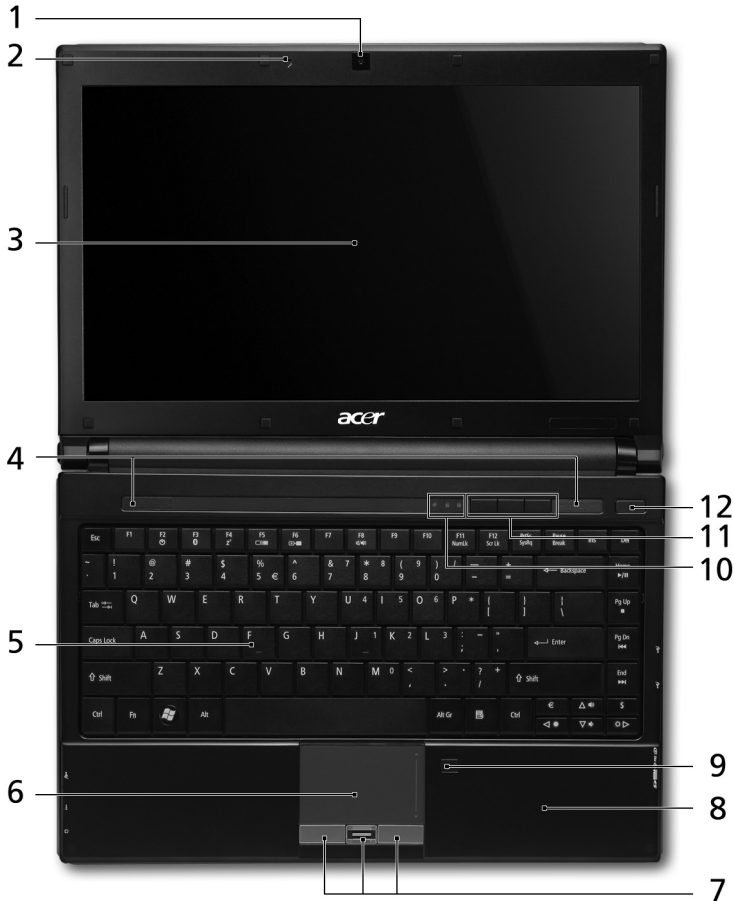

# Your Acer notebook tour

After setting up your computer as illustrated in the **Just for Starters...** poster, let us show you around your new Acer notebook.

## Top view













#	Icon	Item	Description
1		Acer Crystal Eye webcam	Web camera for video communication.

#	Icon	Item	Description
2		Microphone	Internal microphone for sound recording.
3		Display screen	Also called Liquid-Crystal Display (LCD), displays computer output (Configuration may vary by models).
4		Speakers	Left and right speakers deliver stereo audio output.
5		Keyboard	For entering data into your computer.
6		Touchpad	Touch-sensitive pointing device which functions like a computer mouse.
7		Click buttons (left, center* and right)	The left and right buttons function like the left and right mouse buttons. *The center button serves as Acer Bio-Protection fingerprint reader supporting Acer FingerNav 4-way control function (only for certain models).
8		Palmrest	Comfortable support area for your hands when you use the computer.
9		Touchpad toggle	Turns the internal touchpad on and off.
10		HDD	Indicates when the hard disk drive is active.
		Num Lock	Lights up when Num Lock is activated.
		Caps Lock	Lights up when Caps Lock is activated.
11		Communication key	Enables / disables the WLAN / 3G functions.
		Backup key	Launches Acer Backup Management for three-step data backup.
		Acer PowerSmart key	Puts your computer into power-saving mode.
12		Power button / indicator	Turns the computer on and off. / Indicates the computer's power status.

## Hotkeys

The computer employs hotkeys or key combinations to access most of the computer's controls like screen brightness and volume output.

To activate hotkeys, press and hold the **<Fn>** key before pressing the other key in the hotkey combination.

Hotkey	Icon	Function	Description
<b>&lt;Fn&gt; + &lt;F2&gt;</b>		System property	Starts System Property for displaying system information.
<b>&lt;Fn&gt; + &lt;F3&gt;</b>		Bluetooth	Enables/disables the Bluetooth function. (only for certain models)
<b>&lt;Fn&gt; + &lt;F4&gt;</b>		Sleep	Puts the computer in Sleep mode.
<b>&lt;Fn&gt; + &lt;F5&gt;</b>		Display toggle	Switches display output between the display screen, external monitor (if connected) and both.
<b>&lt;Fn&gt; + &lt;F6&gt;</b>		Screen blank	Turns the display screen backlight off to save power. Press any key to return.
<b>&lt;Fn&gt; + &lt;F8&gt;</b>		Speaker toggle	Turns the speakers on and off.
<b>&lt;Fn&gt; + &lt;Δ&gt;</b>		Brightness up	Increases the screen brightness.
<b>&lt;Fn&gt; + &lt;∇&gt;</b>		Brightness down	Decreases the screen brightness.
<b>&lt;Fn&gt; + &lt;Δ&gt;</b>		Volume up	Increases the sound volume.
<b>&lt;Fn&gt; + &lt;∇&gt;</b>		Volume down	Decreases the sound volume.

## Closed front view

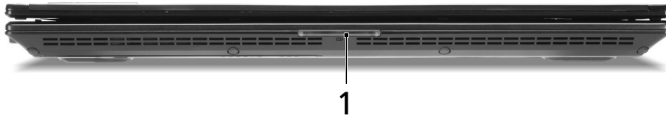

#	Icon	Item	Description
1		Battery	Indicates the computer's battery status. <b>1. Charging:</b> The light shows amber when the battery is charging. <b>2. Fully charged:</b> The light shows blue when in AC mode.



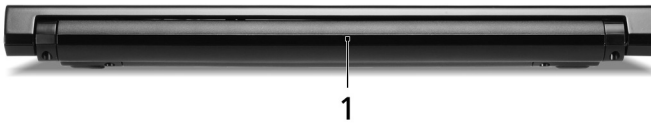

## Rear view

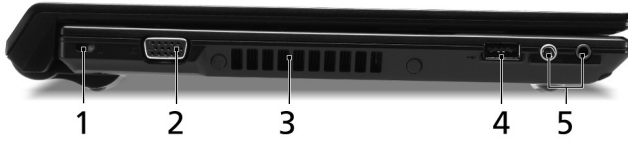

#	Icon	Item	Description
1		Battery bay	Houses the computer's battery pack.





## Left view

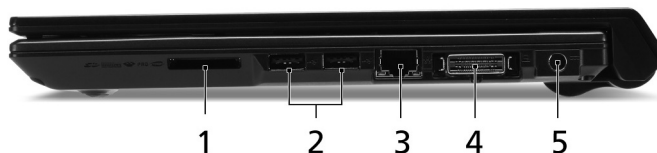

#	Icon	Item	Description
1		Kensington lock slot	Connects to a Kensington-compatible computer security lock. <b>Note:</b> Wrap the computer security lock cable around an immovable object such as a table or handle of a locked drawer. Insert the lock into the notch and turn the key to secure the lock. Some keyless models are also available.
2		External display (VGA) port	Connects to a display device (e.g., external monitor, LCD projector).
3		Ventilation slots	Enable the computer to stay cool, even after prolonged use.
4		USB 2.0 port	Connect to USB 2.0 devices (e.g., USB mouse, USB camera).
5		Microphone-in jack	Accepts inputs from external microphones.
		Headphones/speaker/line-out jack	Connects to audio line-out devices (e.g., speakers, headphones).





## Right view



#	Icon	Item	Description
1		5-in-1 card reader	Accepts Secure Digital (SD), MultiMediaCard (MMC), Memory Stick (MS), Memory Stick PRO (MS PRO), xD-Picture Card (xD). <b>Note:</b> Push to remove/install the card. Only one card can operate at any given time.
2		USB 2.0 port	Connects to USB 2.0 devices (e.g., USB mouse, USB camera).
3		Ethernet (RJ-45) port	Connects to an Ethernet 10/100/1000-based network.
4		Acer EasyPort IV connector	Connects to Acer EasyPort IV.
5		DC-in jack	Connects to an AC adapter.

## Base view



#	Icon	Item	Description
1		Battery bay	Houses the computer's battery pack.
2		Battery lock	Locks the battery in position.
3		Memory compartment	Houses the computer's main memory.
4		Hard disk bay	Houses the computer's hard disk (secured with screws).
5		Ventilation slots and cooling fan	Enable the computer to stay cool, even after prolonged use. <b>Note:</b> Do not cover or obstruct the opening of the fan.
6		Battery release latch	Releases the battery for removal.

# Specifications

Operating system	<ul style="list-style-type: none"> <li>• Genuine Windows Vista®</li> </ul>
Platform	<ul style="list-style-type: none"> <li>• Intel® Core™2 Duo processor*</li> <li>• Intel® Core™2 Solo processor*</li> <li>• Intel® Celeron® mobile processor*</li> <li>• Mobile Intel® GS45 Express Chipset</li> <li>• Intel® Wireless WiFi Link 5100*</li> <li>• Acer InViLink™ Nplify™ 802.11b/g/Draft-N*</li> <li>• Acer InViLink™ 802.11b/g*</li> </ul>
System memory	<ul style="list-style-type: none"> <li>• Dual-Channel SDRAM support</li> <li>• Up to 2 GB of DDR3 1066 MHz memory, upgradeable to 4 GB using two soDIMM modules*</li> <li>• Up to 4 GB of DDR3 1066 MHz memory, upgradeable to 8 GB using two soDIMM modules*</li> </ul>
Display	<ul style="list-style-type: none"> <li>• 16:9 aspect ratio</li> <li>• 13.3" HD 1366 x 768</li> </ul>
Graphics	<ul style="list-style-type: none"> <li>• Mobile Intel® GS45 Express Chipset*</li> <li>• ATI Mobility Radeon™ HD 4330*</li> </ul>
Communication	<ul style="list-style-type: none"> <li>• Integrated Acer Crystal Eye webcam</li> <li>• WLAN: <ul style="list-style-type: none"> <li>• Intel® Wireless WiFi Link 5100*</li> <li>• Acer InViLink™ Nplify™ 802.11b/g/Draft-N*</li> <li>• Acer InViLink™ 802.11b/g*</li> </ul> </li> <li>• WPAN: Bluetooth® 2.1+Enhanced Data Rate (EDR)*</li> <li>• WWAN: UMTS/HSPA at 850/900/1900/2100 MHz and quad-band GSM/GPRS/EDGE (850/900/1800/1900 MHz)</li> <li>• LAN: Gigabit Ethernet; Wake-on-LAN ready</li> </ul>
Audio	<ul style="list-style-type: none"> <li>• High-definition audio support</li> <li>• MS-Sound compatible</li> <li>• Built-in microphone</li> </ul>
Storage subsystem	<ul style="list-style-type: none"> <li>• 2.5" hard disk drive, with enhanced Acer DASP (Disk Anti-Shock Protection)*</li> <li>• Solid state drive*</li> <li>• 5-in-1 card reader</li> </ul>
Privacy control	<ul style="list-style-type: none"> <li>• Enhanced Acer DASP (Disk Anti-Shock Protection)</li> <li>• Acer Bio-Protection fingerprint solution*</li> <li>• BIOS user, supervisor, HDD passwords</li> <li>• Kensington lock slot</li> </ul>

Dimensions and weight	<ul style="list-style-type: none"> <li>• 323.6 (W) x 228 (D) x 26/29.4 (H) mm (12.74 x 8.97 x 1.02/1.10 inches)</li> <li>• 1.65 kg (3.583 lbs.) with 6-cell battery pack</li> </ul>
Power subsystem	<ul style="list-style-type: none"> <li>• ACPI 3.0</li> <li>• 62.16 W 5600 mAh</li> <li>• 3-pin 65 W AC adapter</li> <li>• ENERGY STAR®*</li> </ul>
Special keys and controls	<ul style="list-style-type: none"> <li>• 88-/89-/93- key keyboard</li> <li>• Touchpad pointing device</li> </ul>
I/O interface	<ul style="list-style-type: none"> <li>• Acer EasyPort IV connector</li> <li>• Acer Bio-Protection fingerprint reader</li> <li>• 5-in-1 card reader (SD/MMC/MS/MS PRO/xD)</li> <li>• USB 2.0 port</li> <li>• External display (VGA) port</li> <li>• Headphones/speaker/line-out jack</li> <li>• Microphone-in jack</li> <li>• Ethernet (RJ-45) port</li> <li>• DC-in jack for AC adapter</li> </ul>
Environment	<ul style="list-style-type: none"> <li>• Temperature: <ul style="list-style-type: none"> <li>• Operating: 5 °C to 35 °C</li> <li>• Non-operating: -20 °C to 65 °C</li> </ul> </li> <li>• Humidity (non-condensing): <ul style="list-style-type: none"> <li>• Operating: 20% to 80%</li> <li>• Non-operating: 20% to 80%</li> </ul> </li> </ul>



-----

**Note:** \* Only for certain models



-----

**Note:** The specifications listed above are for reference only. The exact configuration of your PC depends on the model purchased.